

2231
+
BZ 7110

Instruction Manual

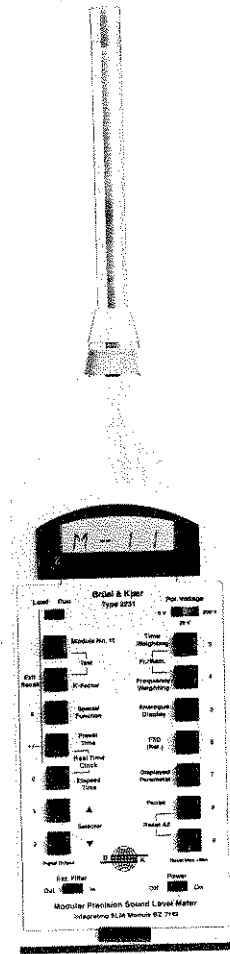

Modular Precision Sound Level Meter

plus Integrating
SLM Application Module

 **Brüel & Kjær**

**Modular Precision
Sound Level Meter Type 2231
plus
Integrating SLM Module BZ7110**

September 1992

.....



.....



.....

Preface: About this Manual

This instruction manual should be used as a reference guide when you are working with Modular Precision Sound Level Meter Type 2231 and Integrating SLM Application Module BZ 7110. For an overview of the instrument, open out the flap on the back cover, which shows a photograph of the front plate and a directory of the pushkeys.

Types of text used in this manual:

To differentiate between pushkeys, displays etc., we use the following typefaces:

Pause Sound level meter pushkeys (in instructions)

Pause Sound level meter pushkeys (in main text)
or

Power Sound level meter switches

“Off” Front plate logos

SPL Sound level meter display
or

S - ERR Computer screen

P <Enter> Computer pushkeys



CONTENTS

| | |
|--|----------|
| 1. Introduction | 1 |
| <hr/> | |
| 2. Setting Up the Sound Level Meter | 5 |
| <hr/> | |
| 3. Module BZ 7110: User Instructions | 19 |
| <hr/> | |
| Pushkey Functions | 19 |
| Special Functions | 38 |
| System Functions | 66 |
| An Example Measurement | 73 |
| Display Messages | 79 |
| <hr/> | |
| 4. Use with a Computer | 83 |
| <hr/> | |
| 5. Use with Other Equipment | 95 |
| <hr/> | |
| 6. Taking care of the 2231 | 107 |
| <hr/> | |
| 7. Specifications and Ordering Information | 109 |
| <hr/> | |
| 8. Appendices | 113 |
| <hr/> | |
| Index | 131 |
| <hr/> | |
| Front Plate and Pushkey Directory | Fold-out |
| <hr/> | |



1.1. The Sound Level Meter

Modular Precision Sound Level Meter Type 2231 is a Type 1 precision instrument in accordance with IEC 651 regulations. It can perform a wide range of measurements, and can be used with a variety of modules. The characteristics of the sound level meter depend on the module that you most recently loaded into it – the module's software, transferred to the sound level meter, adapts the instrument to particular needs. The nature of the measurements that you require will determine those needs.

In general, when the sound level meter receives a signal, it performs several measurements simultaneously (for example, Peak and RMS detection). Therefore, you can look at the Peak and RMS values of the same measurement. A very wide frequency range of 1 Hz to 70 kHz allows measurements in the infrasound and ultrasound regions.

Depending on the module loaded, the sound level meter can perform several special functions, including automatic print-out of data at the end of preset time periods. These print-outs can be in any one of six languages. The sound level meter can also communicate with, and be controlled from, a computer.

The sound level meter has three polarization voltages. This means that you can use almost any Brüel & Kjær Microphone. With Microphone Type 4133 plus extension cable AO 0027, the sound level meter becomes a Type 0 instrument, in accordance with IEC 651 recommendations.

1.1. The Sound Level Meter

Features of the Type 2231 Sound Level Meter include:

- Fulfils IEC 804 Type 1, relevant sections of IEC 651 Type 1 I, and ANSI S1.4-1983 Type 1.
- When used with Microphone Type 4133 and Extension Cable AO 0027, fulfils IEC 804 Type 0 and relevant sections of IEC 651 Type 0 I.
- 24 to 113 dB(A)* measuring range (30 to 133 dB(A)* with attenuator) in 7 overlapping sub-ranges.
- 73 dB Pulse range; 70 dB RMS Linearity range.
- RMS and Peak detection in parallel.
- Internal memory has back-up battery power which prevents loss of application software and data when the instrument is switched off.

* Upper limit for signals of crest factor 10 (=20 dB).

1.2. Integrating SLM Module BZ7110



Fig. 1.1. Application Module BZ 7110

With Application Module BZ 7110, the Type 2231 is an Integrating Sound Level Meter. Potential uses of the BZ 7110/Type 2231 combination are given below:

- Measuring the Sound Pressure Level (SPL).
- Determining the L_{eq} , helping to assess hearing loss risk or noise annoyance.
- Measuring cyclical machine noise.
- Determining the Sound Exposure Level SEL ($= L_{EA}$, in accordance with IEC 804).
- Measuring the Max. and Min. noise levels.
- Assessing machine noise and its average spatial level.
- Measuring sound power levels according to survey method.
- Performing octave or $1/3$ -octave frequency analysis with Filter Sets Type 1624 and 1625.
- Measuring infrasound and ultrasound levels with Filter Type 1627.
- Storing as many as 99 measurement records.

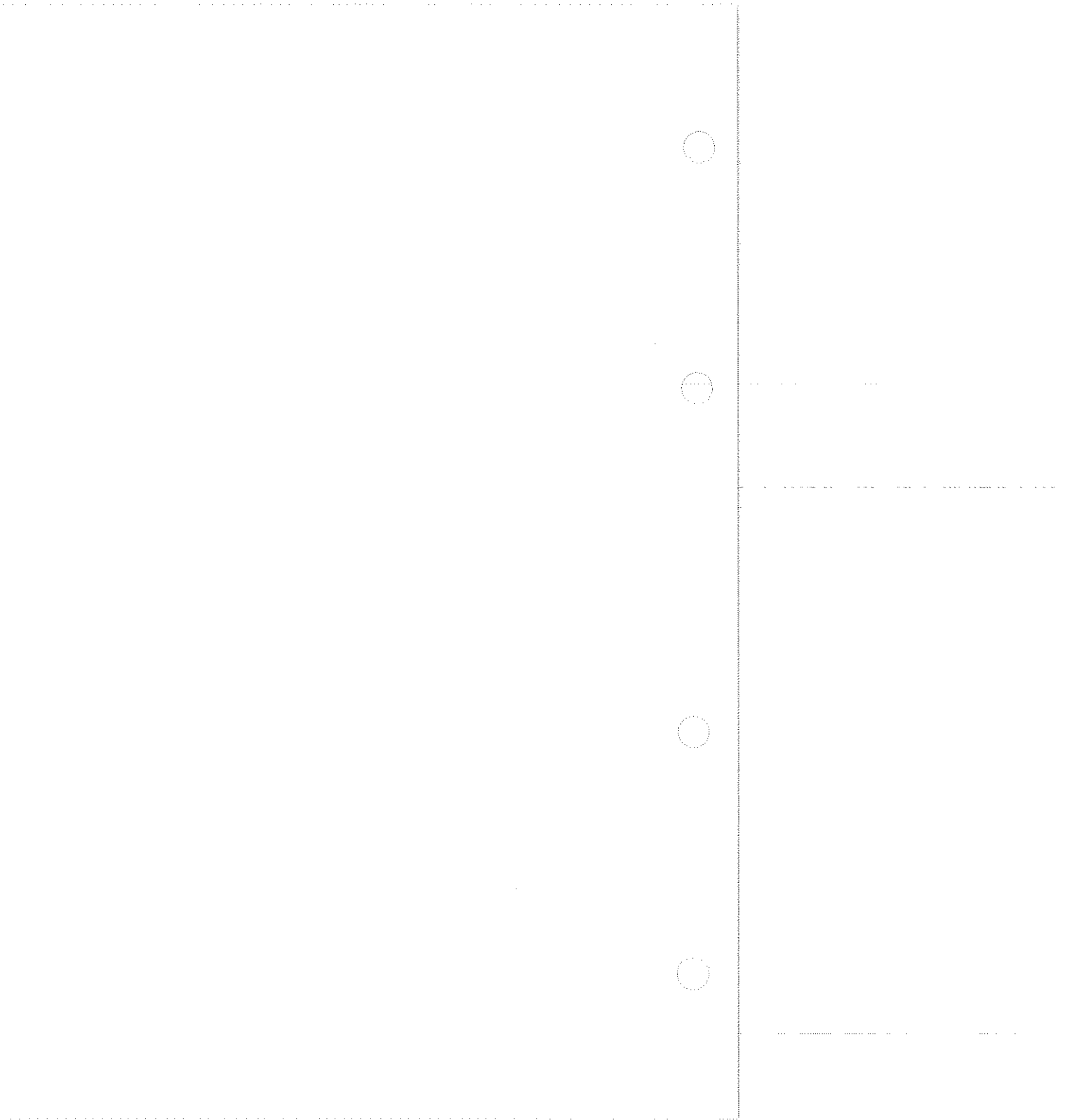

2.1. Introduction

This chapter shows you how to prepare the sound level meter for measurements. There is also a brief discussion on types of sound field and on how they affect measurements made by the sound level meter. For more general information on sound level measurement techniques, we recommend the following texts:

“Measuring Sound”

Brüel & Kjær Booklet BR 0047

“Acoustic Noise Measurements”

Brüel & Kjær Handbook BT 0012–12

“Architectural Acoustics”

Brüel & Kjær Handbook 18–242

Remember: Follow the relevant national or international standards. This will ensure that your measurement technique, and therefore your results, are valid.

2.2. Inserting the Batteries

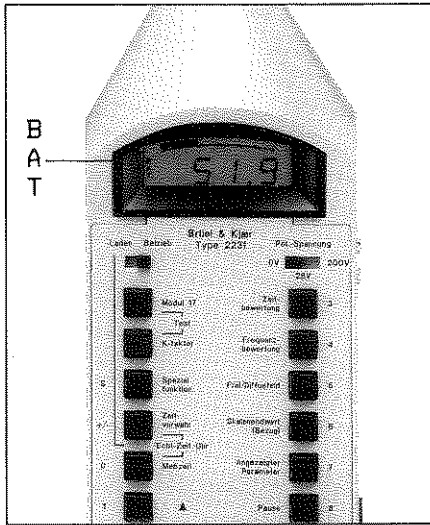

Fig. 2.1. "Battery Low" display

Battery Type: 1.5 V – IEC Type LR6 (B & K No. QB 0013)

No. of Batteries: 4

Battery Life: Approx. 8 hours (Continuous Operation – Alkaline Batteries).

The following displays tell you the condition of the batteries:

Flashing **BAT** appears on the display (see Fig. 2.1): approximately 30 min. operation remaining.

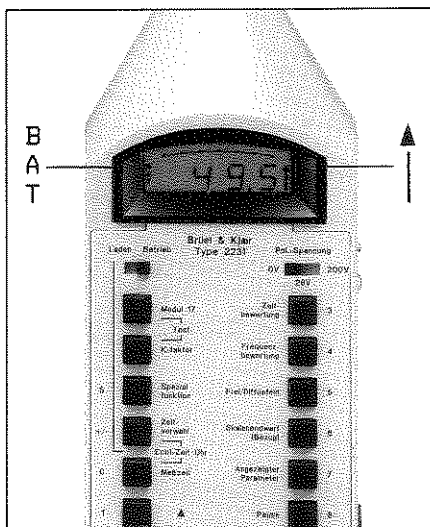

Fig. 2.2. "Battery Too Low for Accurate Operation" display

Flashing **BAT** with constant ↑ (see Fig. 2.2): battery too low for accurate operation. Replace batteries.

2.2. Inserting the Batteries

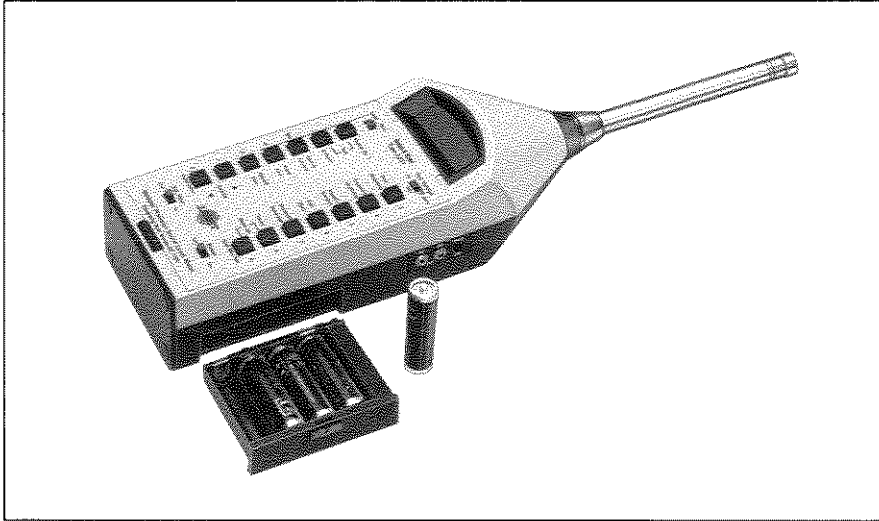

Fig. 2.3. Inserting the batteries

Inserting New Batteries:

1. Slide down the lock on the battery drawer.
2. Pull out the battery drawer.
3. Remove the old batteries.
4. Insert new batteries according to the polarity indicated inside the drawer.
5. Push the drawer back into place while pressing down on the lock until the drawer clicks shut securely.

When Filter Set Type 1624, 1625, or 1627 is connected to the sound level meter, the batteries of the filter set act as a back-up power supply for the sound level meter, even when the **Ext. Filter** switch is in the “**Out**” position. With a filter set attached, batteries in the sound level meter can be changed as described above, without interrupting a measurement.

2.2. Inserting the Batteries

Batteries and the Memory of the Type 2231:

The sound level meter has a continuous memory which lets it retain application module programs even when it is switched off. The memory has its own back-up battery, which is automatically recharged when the sound level meter is powered by the batteries in the battery drawer and remains charged when the power is switched off. You can remove the main batteries without affecting the retained data. Regular usage will keep the back-up battery sufficiently charged. The back-up battery is fully charged when the sound level meter has been in use for an accumulated period of 20 hours. Fully charged, the memory retains an application program for about 3 months, even if the sound level is without its main batteries.

The above charge times are typical values, and apply when the sound level meter is used at room temperature. At temperatures below +10°C, the back-up batteries are not charged.

If the main batteries are not inserted and no power is supplied to the sound level meter for some time, the back-up battery will become insufficiently charged. This disables the memory, so you have to re-load the application program and reset the settings on the Real Time Clock and the status of the Monitor. The sound level meter display tells you which values to re-enter.

Note: For long-term storage remove the batteries and keep the instrument in a dry place. When using the instrument, always have spare batteries with you.

2.3. Mounting the Microphone

Before mounting any microphone, please observe the following precautions:

- Gently screw in microphones, input stages, protection grids, extension cables and preamplifiers.
- Keep dust and foreign objects off the microphone diaphragm.
- If the diaphragm must be cleaned, brush it **very lightly** with a soft cotton wool swab. Otherwise, do not touch it.

Mounting the Standard Microphone:

1. Gently screw Microphone Type 4155 (supplied with the Type 2231) onto Input Stage ZC0020.
2. Switch **Pol. Voltage** to “0V”.
3. Insert the Input Stage ZC0020 into the input stage socket: make sure that the key follows the key slot correctly (see Fig. 2.4).
4. Secure by turning the threaded retaining ring.

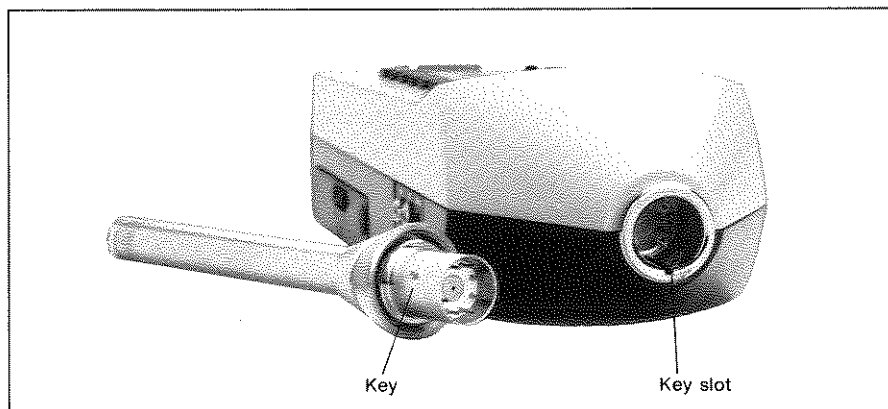

Fig. 2.4. Connection of the Input Stage ZC0020 to the sound level meter

2.3. Mounting the Microphone

Modular Precision Sound Level Meter Type 2231 can use almost any microphone in the Brüel & Kjær range. There are some restrictions, and you should use special application microphones only when they are completely necessary. Section 8.1 tells you why you might use certain microphones, how best to use them, and what their limitations are.

One special application deserves mention here:

Type 0 Sound Level Meter:

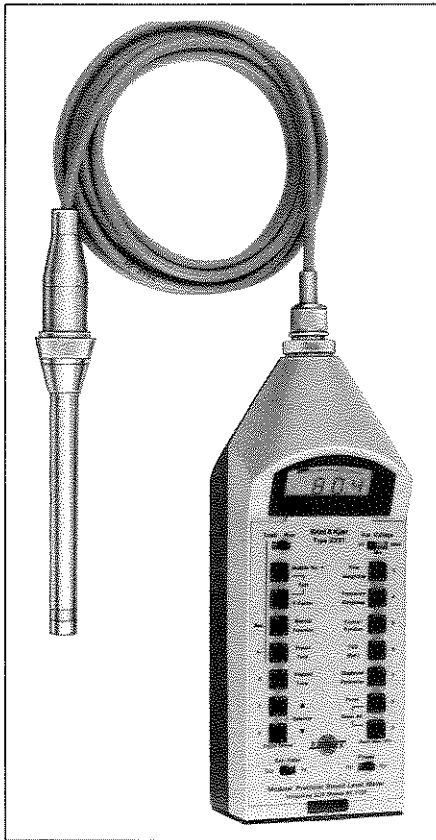

Fig. 2.5. Type 0 sound level meter

1. Gently screw Microphone Type 4133 onto Input Stage ZC 0020.
2. Insert the Input Stage ZC 0020 into the female connection end of Extension Cable AO 0027 (or Cable AO 0134).
3. Insert the male connection end of the extension cable into the input stage socket of the sound level meter.
4. Secure by turning the threaded retaining ring.
5. Switch **Pol. Voltage** to "200V".
6. For measurements according to IEC, set **Frontal/Random** to **Fr .** (Frontal). For measurements according to ANSI, set **Frontal/Random** to **Rdm .** (Random). See section 3.6.

2.4. Mounting the Front Plate

Each application module has a front plate which mounts onto the sound level meter. The pushkey text on the front plate refers only to the features of the relevant application module, whose name is given at the bottom of the front plate. To mount the front plate, see Fig. 2.6.

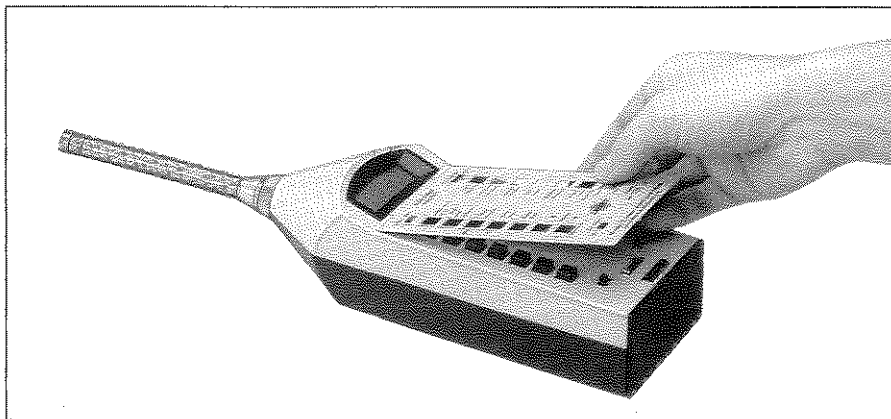

Fig. 2.6. Mounting the front plate

2.5. Loading the Module

The module fits into the interface socket at the back of the sound level meter (see Fig. 2.7). The interior frames of both the module and the socket are shaped so that they fit each other securely, so when inserting the module, make sure that it and the socket are correctly aligned.

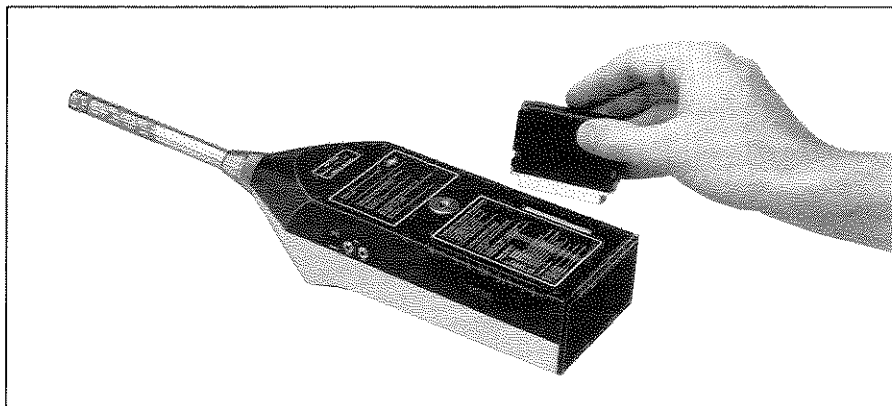

Fig. 2.7. Inserting the module

Note:

- Make sure that the power to the sound level meter is off before you insert the module into, or remove it from, the interface socket. This protects the module from possible short circuits.
- The terminals of the Type 2231 and the module are protected from static electricity by black plastic covers. Remove these covers before inserting the module, and replace them when the application program has been loaded.

2.5. Loading the Module

With the module securely inserted into the socket at the back of the sound level meter, you can load its program into the sound level meter. Before switching on the instrument, make sure that the **Pol. Voltage** switch is set to “0V” for the standard microphone (see section 2.3) and that the **Ext. Filter** switch is set to “Out”.

1. Switch **Power** to “On”.
2. Switch **Run/Load** to “Load”
3. Press **Module No. 11**.

The program loads from the application module into the internal program- and data-memory. Once loaded, the program number **M - 11** is displayed as shown.

4. Switch **Load/Run** to “Run”.

After about 1 second's delay, the sound level meter starts measuring the instantaneous sound pressure level (SPL).

5. Switch **Power** to “Off”.
6. Remove the module from the sound level meter interface socket.
7. Put the covers back over the interface socket of the sound level meter and the pins of the module.

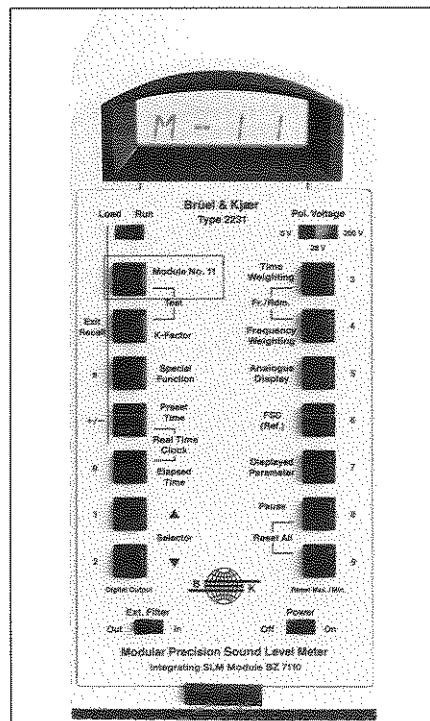

2.5. Loading the Module

Alternative loading method:

If you follow the procedure given on the previous page, and find that the module program fails to load into the sound level meter, check that all the conditions necessary for successful loading are present. If they are, then perform the alternative loading method described below. Always use the conventional loading method before the alternative method.

1. Switch **Run/Load** to "**Load**".
2. Press and hold **Module No. 11**.
3. Switch **Power** to "**On**".

The program loads from the application module into the internal program- and data- memory. When the program is loaded, the program number **M - 11** is displayed as shown.

4. Release **Module No. 11**.
5. Switch **Load/Run** to "**Run**".

After about 1 second's delay, the sound level meter starts measuring the instantaneous sound pressure level (SPL).

6. Follow steps 5, 6 and 7 on the previous page.

Effects of loading a module:

When a module loads its program into the sound level meter, the **K-Factor**, **Special Functions**, and **Preset Time** are set to zero. The instrument sets other parameters as follows:

| | |
|----------------------------|---------------------------------|
| Time Weighting: | : Fast |
| Frequency Weighting | : A |
| Frontal/Random | : Frontal |
| FSD (Meas. Range) | : Highest range (120 dB) |
| Displayed Parameter | : SPL |

Note: The current set-up of the parameters listed above can be stored by using System Function 6. That set-up can be loaded by loading Module BZ7110 in a special way (see section 3.20.3).

2.6. Checking the Module Status

1. Switch **Load/Run** to “**Run**”.
2. Press **Module No. 11**.

The display reads **M - 11**. This number indicates what program (that of Module BZ7110) is now residing in the central memory of the sound level meter. Other application modules show other numbers (**M - 5**, **M - 15** etc.) when you load them. At any one time, the software from only one module can be stored. When a new application module is loaded, its software replaces the software which was last loaded into the memory of the sound level meter. The functions associated with each pushkey are defined by the software in the central memory, and are not the same for each module.

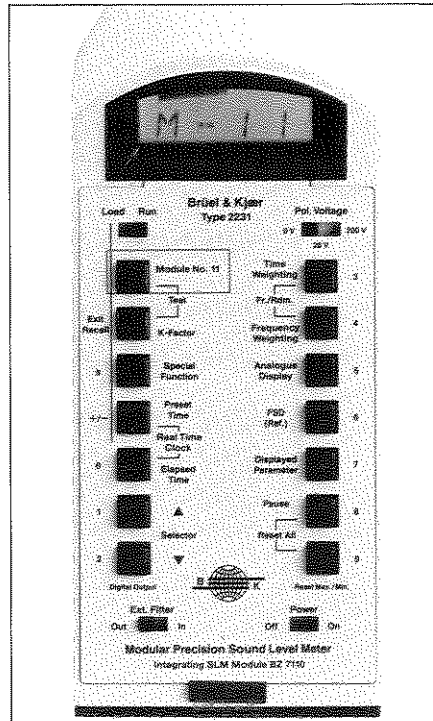

2.7. Calibrating the Sound Level Meter

There are three methods of calibrating the sound level meter: with the internal generator of the sound level meter; with Sound Level Calibrator Type 4230; with Pistonphone Type 4228. We shall now describe each of these methods. All calibration must be done after loading the application module (see section 2.5).

Calibrating with the Internal Generator:

1. Key in the correct K-Factor for the microphone (see section 3.2).
2. Set the measuring range **FSD** to **REF** (see section 3.7).
3. Set **Displayed Parameter** to **SPL** (see section 3.8).
4. Use the supplied Screwdriver QA0001 to adjust the **Sens. Adj.** potentiometer on the side of the sound level meter (see Fig. 2.8) until the display shows a value of **94 . 0 dB + K-Factor**.

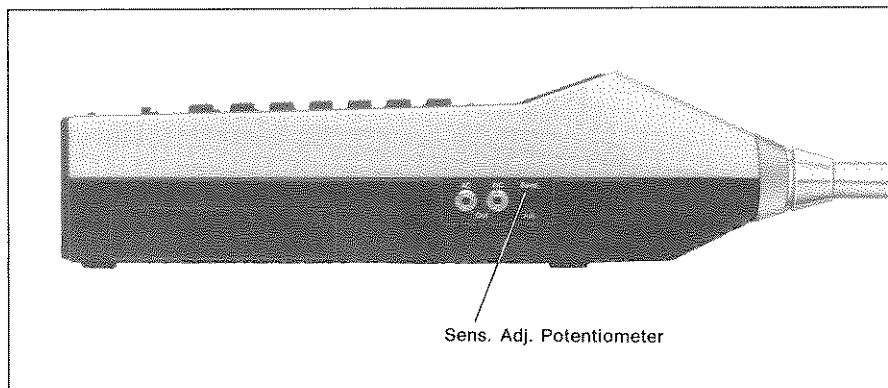

Fig. 2.8. Side view of the sound level meter showing the Sens. Adj. potentiometer

2.7. Calibrating the Sound Level Meter

Calibrating with Sound Level Calibrator Type 4230:

1. Key in the correct K-Factor for the microphone (see section 3.2).
2. Set the measuring range **FSD** to **110 dB + K-Factor** (see section 3.7).
3. Set **Displayed Parameter** to **SPL** (see section 3.8).
4. Fit the calibrator with the appropriate microphone adaptor and place it over the microphone so that it makes a snug, steady fit.
5. Switch on the calibrator.
6. Use the supplied Screwdriver QA0001 to adjust the **Sens. Adj.** potentiometer on the side of the sound level meter (see Fig. 2.9) until the display shows a value of **93.8 dB**.
For microphones other than Type 4155, see the Type 4230 Instruction Manual.

Calibrating with Piston-phone Type 4228:

1. Key in the correct K-Factor for the microphone (see section 3.2).
2. Set **Frequency Weighting** to **C, Lin.** or **All-Pass** (see section 3.5).

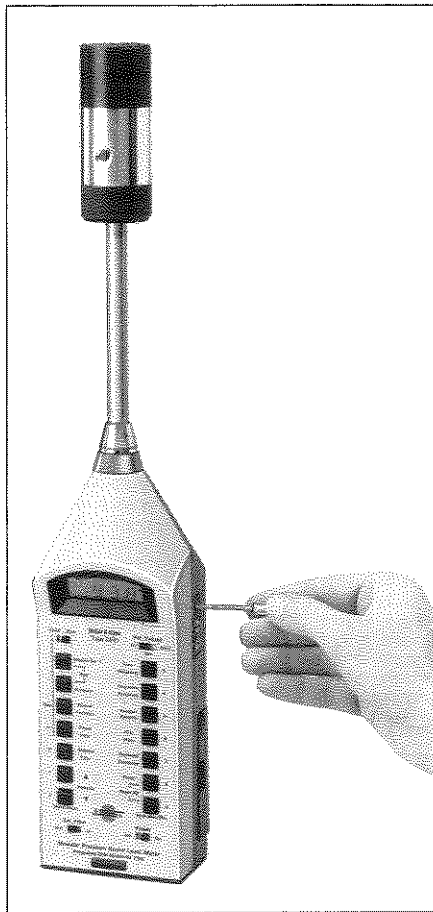

Fig. 2.9. Calibration with Sound Level Calibrator Type 4230

2.7. Calibrating the Sound Level Meter

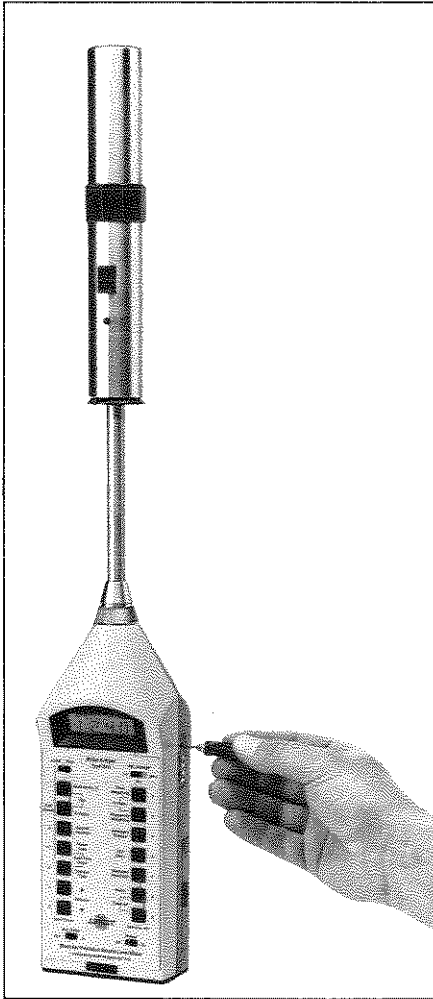

Fig. 2.10. Calibration with Pistonphone Type 4228

3. Look at Table 2.1, and set the measuring range **FSD** (see section 3.7) for the microphone that you are using.
4. Set **Displayed Parameter** to **SPL** (see section 3.8).
5. Fit the pistonphone with the appropriate microphone adaptor and place it over the microphone so that it makes a snug, steady fit.
6. Switch on the pistonphone.
7. Use the supplied Screwdriver QA 0001 to adjust the **Sens. Adj.** potentiometer on the side of the sound level meter (see Fig. 2.10) until the display shows a value of **124.0 dB**. This is the nominal level. The actual level depends on the surrounding environmental conditions*.

| Microphone Type | Full Scale Deflection |
|--|-----------------------|
| 4155 4165, 4166 4144, 4145, 4160 4129, 4176 | 120 dB + K-Factor |
| 4155 + ZF 0020 4133, 4134, 4149 4135, 4136 4138 | 110 dB + K-Factor |

T00678GB0

Table 2.1. FSD settings on the 2231 when used with various microphones

* See calibration chart for the 4228

3.1. Test

Use **Test** when you want to make sure that the display is working correctly. The display shows the Overload symbol (†), the Battery Low symbol (BAT) and each segment of each digital character. **Test** does not affect the quasi-analogue portion at the top of the display, which continues to show the level of the incoming signal.

Using Test:

1. Switch **Load/Run** to “**Run**”.
2. Simultaneously press **Module No. 11** and **K-Factor** (these are linked by the “**Test**” logo).

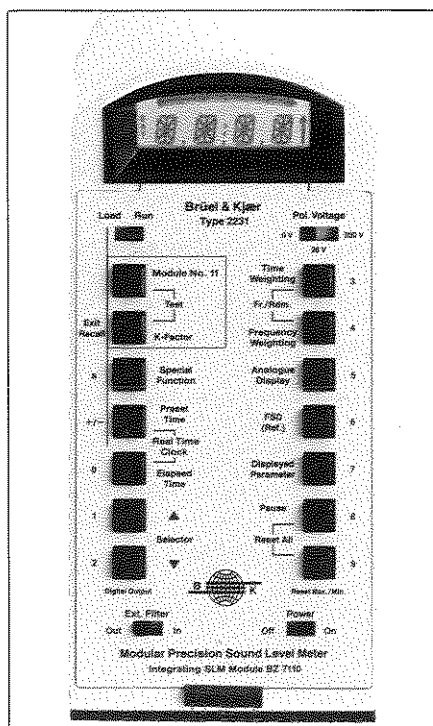

Note: Using **Test** does not interrupt or affect the measurement in progress.

3.2. K-Factor

The K-Factor is a sensitivity correction for the microphone currently being used with the sound level meter (K-Factor = 0; nominal sensitivity = 50 mV/Pa for Microphone Type 4155). The K-Factor for a microphone can be found on the calibration sheet supplied with it.

Checking and Changing the K-Factor:

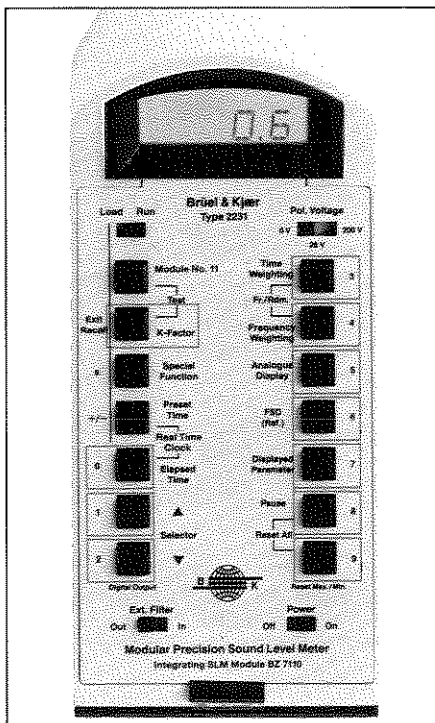

Checking:

1. Switch **Load/Run** to “**Run**”.
2. Press **K-Factor**.

The value of the K-Factor currently stored in the memory is displayed. A typical example (for a Type 4155 Microphone) is shown.

Changing:

1. Switch **Load/Run** to “**Load**”.
2. Press **K-Factor**.

The value of the K-Factor currently stored in the memory is displayed (after loading the software, 0 . 0 is displayed as shown).

3. Use pushkeys **0** to **9** and **+/-** to key in the correct K-Factor.

Three significant digits must be keyed in. The most significant digit is keyed in first. The digits are shifted along the display from right to left, thereby allowing corrections to be made. A negative K-Factor should be displayed with a minus (-) sign beside it. A positive K-Factor should have no sign beside it.

4. Switch **Load/Run** to “**Run**”.

3.2. K-Factor

The K-Factor that has been entered is handled by the instrument as a digital correction to the display. The K-Factor adjustment range is -60 dB to +99 dB, which allows the use of almost any Brüel & Kjær Microphone. Note that the DC/AC output signals do not include the microphone K-Factor.

Note:

- Checking the status of the **K-Factor** does not interrupt or affect the measurement in progress.
- It is possible to change the **K-Factor** value even after a measurement has been completed. If you change the **K-Factor** while the instrument is in **Pause**, the digitally displayed results will be changed without starting new measurements.

3.3. Real Time Clock

Real Time Clock shows the time in hours, minutes and seconds.

Checking the Real Time Clock:

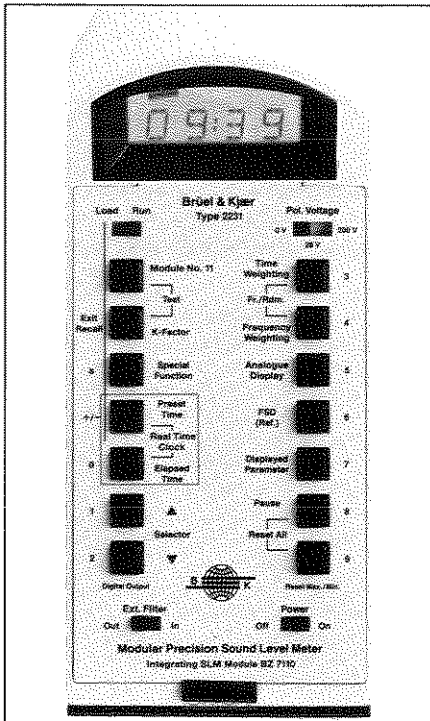

1. Switch **Load/Run** to **“Run”**.
2. Simultaneously press the **Preset Time** and **Elapsed Time** keys (these keys are linked by the **“Real Time Clock”** logo).
The display shows the hours and minutes part of the real time clock (h h : m m).
3. Press **s** while still pressing the pushkeys indicated in step 2.
The display shows the seconds part of the real time clock (s s).

Note: To set the the **Real Time Clock**, and set and read the calendar, use the System Functions (see section 3.16).

3.4. Time Weighting

A **Fast**, **Slow** or **Impulse** time weighting can be applied to the incoming signal. These time weightings are in accordance with IEC 651.

Checking and Changing the Time Weighting:

Checking:

Press **Time Weighting**.

The currently selected time weighting is displayed as shown in the example.

Changing:

Simultaneously press **Time Weighting** and **Selector ▲** or **Selector ▼**.

The selected time weighting is displayed as long as the **Time Weighting** key is pressed down.

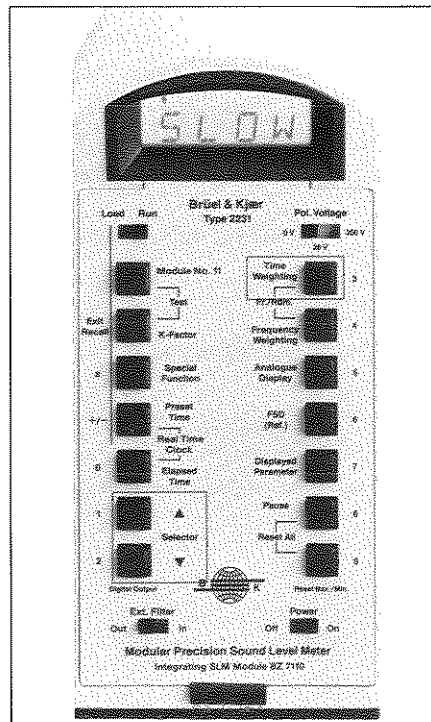

Note:

- Checking the **Time Weighting** does not interrupt or affect the measurement in progress.
- If you change the **Time Weighting**, a new measurement automatically starts. Make sure you have stored or recorded any desired data before you change the **Time Weighting**.

3.5. Frequency Weighting

Four built-in frequency filters give the following frequency weightings (see also Figs. 8.8 and 8.9 in section 8.3):

- A : "A" weighted, as per IEC 651
- C : "C" weighted, as per IEC 651
- L □ : Linear 10 Hz to 20 kHz
- L ▯ ▯ ▯ : All Pass 1 Hz to 70 kHz

The AC and DC output signal and the signal sent to the external filter set are also frequency weighted.

Checking and Changing the Frequency Weighting:

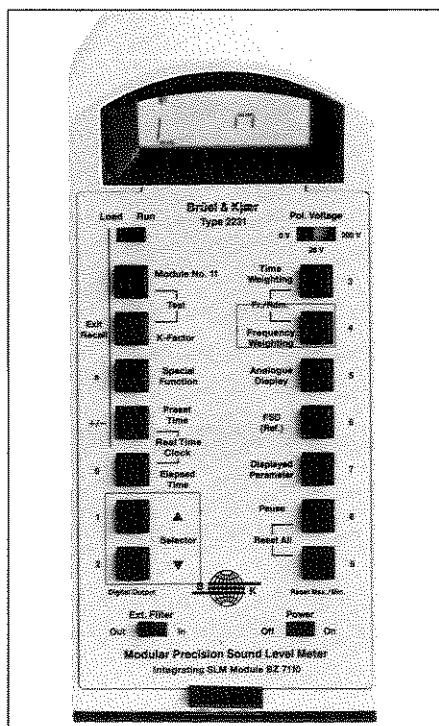

Checking:

Press **Frequency Weighting**.

The status of the currently selected frequency weighting is displayed as shown in the example.

Changing:

Simultaneously press **Frequency Weighting** and **Selector ▲** or **Selector ▼**.

3.5. Frequency Weighting

Note:

- Checking the **Frequency Weighting** does not interrupt or affect the measurement in progress.
- If you change the **Frequency Weighting**, a new measurement automatically starts. Make sure you have stored or recorded desired data before you change the **Frequency Weighting**.

3.6. Frontal/Random

Section 8.2 guides you in the selection of either frontal or random sound incidence correction. Remember, random sound incidence correction is valid only when you are using 1/2 inch free-field corrected microphones (e.g. Type 4155). For all other microphones, frontal sound incidence correction should be chosen.

Checking and Changing the Frontal/Random Status:

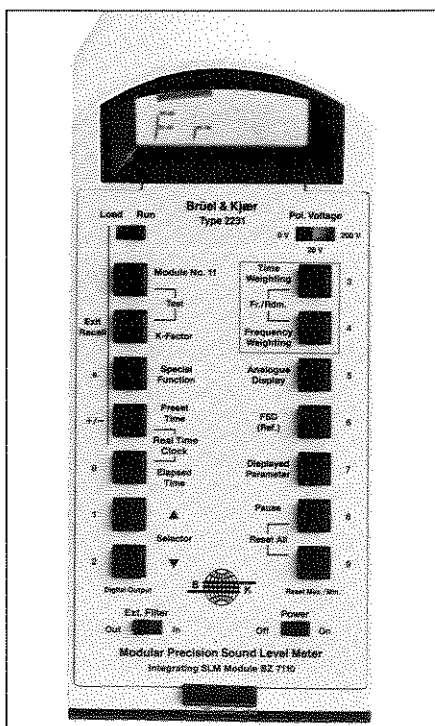

Checking:

Simultaneously press **Time Weighting** and **Frequency Weighting** (these are linked by the “Fr/Rdm” (Frontal/Random) logo).

The display tells you whether the Frontal (**Fr**) or Random (**Rdm**) status is currently stored in the program memory.

Changing:

Simultaneously press **Frontal/Random** and **Selector ▲** or **Selector ▼**.

Note:

- Checking the **Frontal/Random** status does not interrupt or affect the measurement in progress.
- If you change the **Frontal/Random** status, a new measurement automatically starts. Make sure you have stored or recorded desired data before you change the **Frontal/Random** status.

3.7. Full Scale Deflection (FSD)

Seven overlapping 70 dB measuring ranges are available. These are as follows:

| Without ZF 0020 | With ZF 0020 |
|---------------------------|---------------------------|
| 60 to 130 dB (120 dB FSD) | 80 to 150 dB (140 dB FSD) |
| 50 to 120 dB (110 dB FSD) | 70 to 140 dB (130 dB FSD) |
| 40 to 110 dB (100 dB FSD) | 60 to 130 dB (120 dB FSD) |
| 30 to 100 dB (90 dB FSD) | 50 to 120 dB (110 dB FSD) |
| 20 to 90 dB (80 dB FSD) | 40 to 110 dB (100 dB FSD) |
| 10 to 80 dB (70 dB FSD) | 30 to 100 dB (90 dB FSD) |
| 0 to 70 dB (60 dB FSD) | 20 to 90 dB (80 dB FSD) |

700676GB0

Table 3.1. Measuring Ranges of Type 2231

These ranges allow measurements from 24 to 130 dB(A) for sinusoidal signals. For signals with a high crest factor, the ranges are reduced correspondingly. If you use the supplied 20 dB Attenuator ZF 0020, you will get a measuring range from 30 to 150 dB(A). When you use ZF 0020, key in an additional +20 dB as well as the K-Factor of the microphone (see section 3.2). If you do this, the readings on the digital display will show a sound level which has been corrected for the presence of the attenuator.

If you use Filter Sets Type 1624 and 1625, you can measure levels well below 24 dB in many of the octave and $\frac{1}{3}$ -octave bands. The actual noise floor of the 2231 plus microphone in each bandwidth is shown in Figs. 8.12 and 8.13 in section 8.3.

3.7. Full Scale Deflection (FSD)

Checking and Changing the FSD:

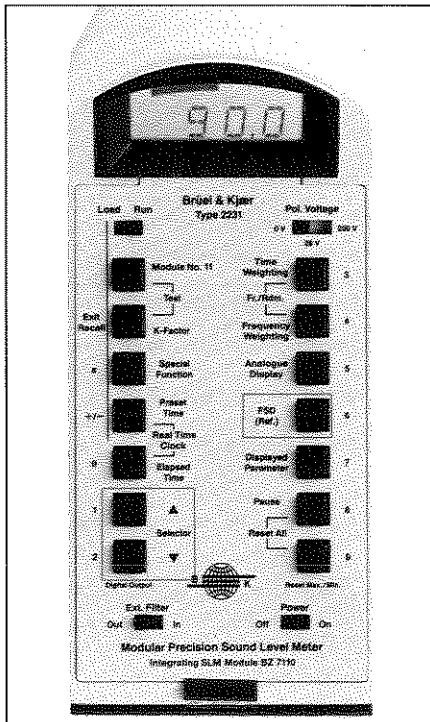

Checking:

Press **FSD**.

The current FSD is displayed as shown in the example.

Changing:

Simultaneously press **FSD** and **Selector ▲** or **Selector ▼**.

Note that the **Selector** keys will change the FSD only when the quasi-analogue portion of the display is showing. Therefore, when you use the **Selector** keys to change the FSD, please make sure that the FSD value actually changes.

The selected FSD is displayed as long as the **FSD** pushkey is pressed down.

Note:

- Checking the **FSD** does not interrupt or affect the measurement in progress.
- The K-Factor is added to the **FSD** value as well as all measurement values shown on the display. For example, if you had a K-Factor of 1.1, the FSD would be displayed as 91.1 ($90.0 + 1.1$).
- The internal reference signal ($94 \text{ dB} + \text{K-Factor at } 1000 \text{ Hz}$) is accessed by **FSD**. Simultaneously press **FSD** and **Selector ▲** until **REF** appears on the sound level meter display.
- If you change the **FSD**, a new measurement automatically starts. Make sure you have stored or recorded desired data before you change the **FSD**.

3.8. Displayed Parameter

When it receives an acoustic signal, the sound level meter (with Integrating SLM Module BZ7110) measures the signal in several ways. As a result, the sound level meter can display a number of the signal's acoustical characteristics. These are the **Displayed Parameters**, and they are given below.

| | |
|-------------|---|
| SPL | : Max. RMS level in 1 second interval (in accordance with IEC 651) |
| LEQ | : Equivalent continuous sound level (in accordance with IEC 804) |
| SEL | : Sound Exposure Level (= L_{EA} , in accordance with IEC 804) |
| INST | : Sampled RMS level in 1 second interval |
| MINL | : Min. RMS level since current measurement began |
| MAXL | : Max. RMS level since current measurement began |
| MAXP | : Max. Peak level since current measurement began |
| PEAK | : Max. Peak level in 1 second interval |
| UNR | : Sound level under range (% of measurement period) |
| OVR | : Sound level over range (% of measurement period) |
| OVL | : Sound level overloading instrument (% of measurement period) |

3.8. Displayed Parameter

Checking and Changing the Displayed Parameter:

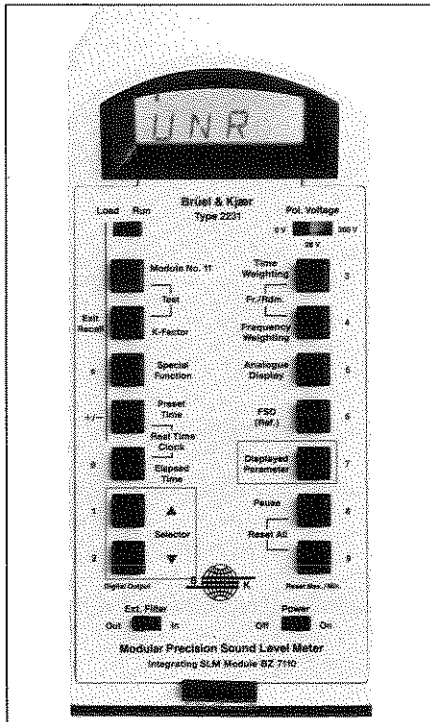

Checking:

Press **Displayed Parameter**.

The current **Displayed Parameter** is displayed as shown in the example.

Changing:

Simultaneously press **Displayed Parameter** and **Selector ▲** or **Selector ▼**.

The selected **Displayed Parameter** is shown as long as you press the **Displayed Parameter** pushkey. When you release the pushkey, the display shows the measured value of that parameter.

Note:

- Checking the **Displayed Parameter** does not interrupt or affect the measurement in progress.
- Changing the **Displayed Parameter** does not interrupt or affect the measurement in progress.

3.9. Preset Time

The sound level meter can automatically stop a measurement at the end of a period whose length is defined by you when you enter values into the **Preset Time** function. The preset time can range from 1 second to 99 hours 59 minutes and 59 seconds. Measurements can be automatically output or stored at the end of a preset measurement period by using the **Digital Output** and **Store Record** special functions (see sections 3.15.3, 3.15.4 and 3.15.5). Example preset times, with their applications, are as follows:

- 5 m : Spatial average in a room
- 1 h : Traffic hourly L_{eq}
- 24h : Community noise measurements (24h L_{eq})

Checking the Preset Time:

1. Switch **Load/Run** to “**Run**”.
2. Press **Preset Time**.

The display shows the hours and minutes part of the current **Preset Time** (hh : mm).

3. Keep **Preset Time** pressed down, and press **s**.

The display shows the seconds part of the current **Preset Time** (ss).

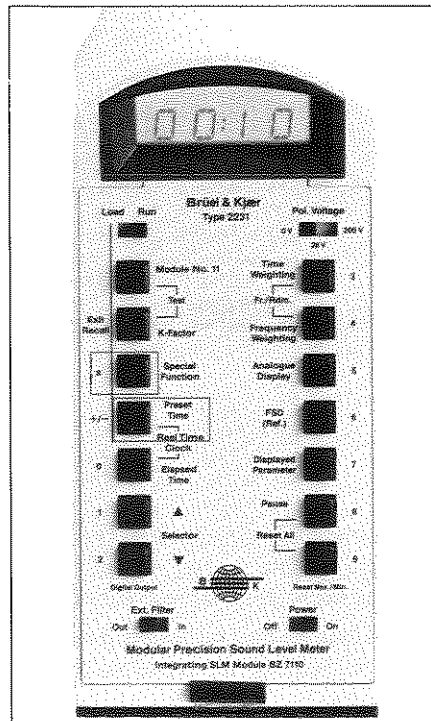

Note: Checking the **Preset Time** does not interrupt or affect the measurement in progress.

3.9. Preset Time

Changing the Preset Time:

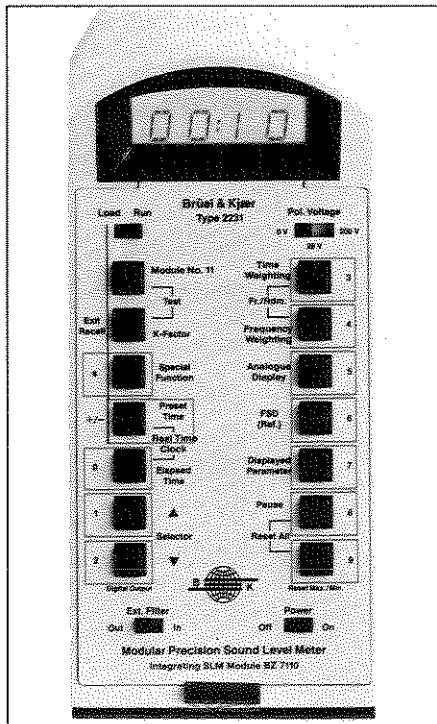

1. Switch **Load/Run** to “**Load**”.

2. Press and release **Preset Time**.

The display shows the hours and minutes part of the **Preset Time** (hh:mm). The default reading is 00.00.

3. Use keys **0** to **9** to key in hh:mm of the **Preset Time**. The digits are shifted along the display from right to left, thereby allowing corrections to be made.

4. Press and hold **s**.

The display shows the seconds part of the **Preset Time** (ss). The default reading is 00.

5. Use keys **0** to **9** to key in ss of **Preset Time**. The digits are shifted along the display from right to left, thereby allowing corrections to be made.

6. Switch **Load/Run** to “**Run**”.

Note:

- The special functions determine if the sound level meter stores or outputs data at the end of a preset measurement period, and what it does after store or output (see sections 3.15.3, 3.15.4 and 3.15.5).
- No data is lost between preset measurement periods when the sound level meter is performing automatic storage of measurement results (see section 3.15.4).
- If, for example, you key in 65 minutes, this will be corrected to 1 hours 5 minutes when you check the **Preset Time**.

3.10. Elapsed Time

The **Elapsed Time** function lets you see how much time has passed since the start of the measurement, i.e. since you did one of the following:

- Reset the **K-Factor** or **Special Function** (unless the instrument is in pause, see section 3.13)
- Reset certain parameters (**Time Weighting**, **Frequency Weighting**, **FSD**).
- Pressed **Reset All**
- Used one of the System Functions (see section 3.16.2).

Checking the Elapsed Time:

1. Press **Elapsed Time**.

The display shows the hours and minutes part of the Elapsed Time (hh : mm).

2. Keep pressing **Elapsed Time** and press **s**.

The display shows the seconds part of the Elapsed Time (ss).

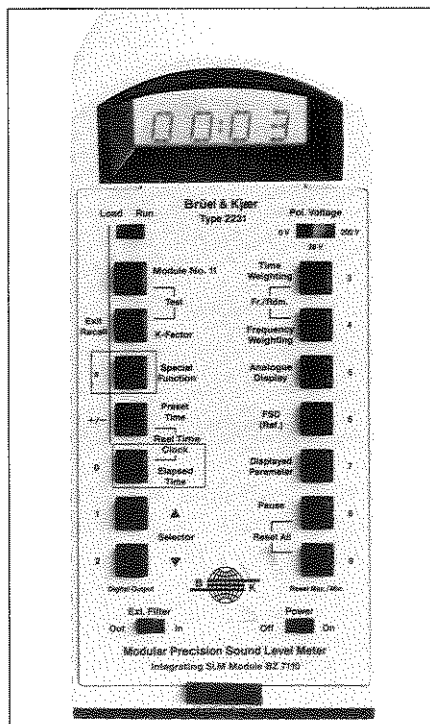

Note: Checking the **Elapsed Time** does not interrupt or affect the measurement in progress.

3.11. Reset All

Pressing this pushkey resets all measurement, calculation and measurement time memories. A new measurement then begins.

Resetting the Sound Level Meter:

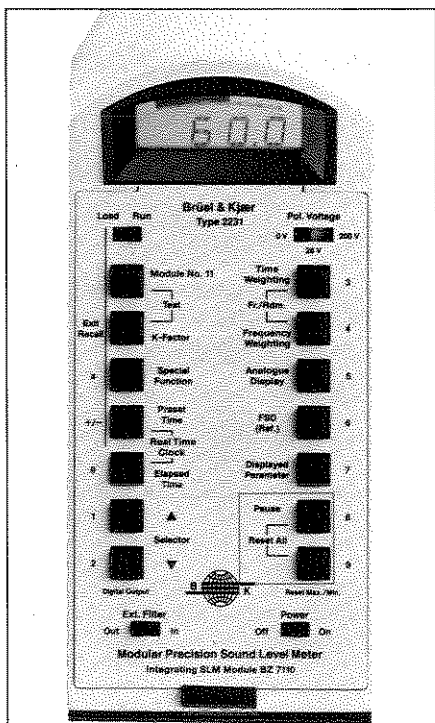

Simultaneously press **8** and **9** (these pushkeys are linked by the “Reset All” logo).

Note: Reset All does not change the following: **K-Factor**; **Special Function**; **Preset Time**; **Time Weighting**; **Frequency Weighting**; **Frontal/Random**; **FSD**.

3.12. Reset Max./Min.

Pressing this pushkey resets MINL, MAXL and MAXP without resetting the other parameters. L_{eq} and SEL measurements continue without interruption.

Resetting Max/Min:

Press **Reset Max/Min**.

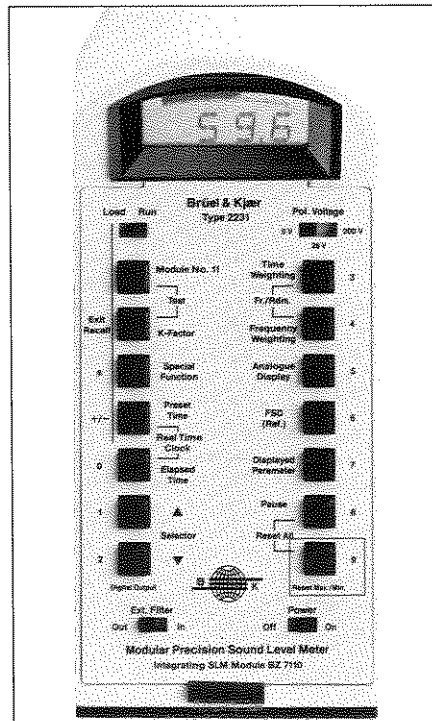

3.13. Pause

If you press **Pause** while a measurement is in progress, the sound level meter completes its current 1 s measurement cycle and then pauses (this also happens at the end of a Preset Time if you have chosen a particular Return Code with the Digital Output special function – see section 3.15.3).

Entering and Exiting Pause:

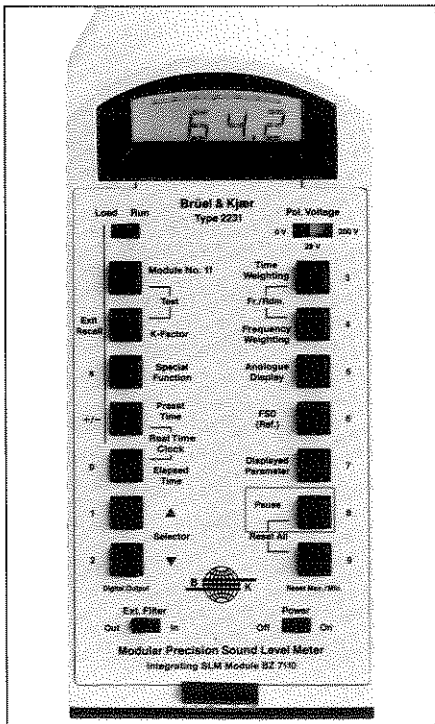

1. Press **Pause**.

The display shows the value of the measured parameter when **Pause** was pressed. Both measurements and the elapsed time counter are now temporarily stopped.

2. Press **Pause** again.

The pause condition is cancelled – the measurement continues, as does the elapsed time counter.

Note:

- If, during a pause, you change the **Time Weighting, Frequency Weighting, Frontal/Random** or **FSD**, the pause condition is cancelled, and a new measurement automatically starts.
- If the sound level meter is switched off during a pause, it will be in the pause condition when it is switched on again.
- During a pause, all measured data (e.g. SPL, SEL, Elapsed Time etc.) is retained.

3.14. Analogue Display

When used with the BZ7110, the 2231 has two display modes: normal and differential.

Normal: This is the display mode that you will usually see. It has a 60 dB range with 2 dB resolution. It shows RMS or Peak values, depending on the Internal Parameters special function that you have chosen (see section 3.15.7).

Differential: In this mode, the SPL current at the time of pressing the **Analogue Display** pushkey becomes the centre value for the display. Any further measurements are shown relative to this centre value. To change the centre value by ± 1 dB at a time, use the **Selector** keys. The differential display has a ± 3 dB range and 0.2 dB resolution.

1. Press **Analogue Display**.

The differential display appears.

2. Press **Analogue Display** again.

The display returns to normal.

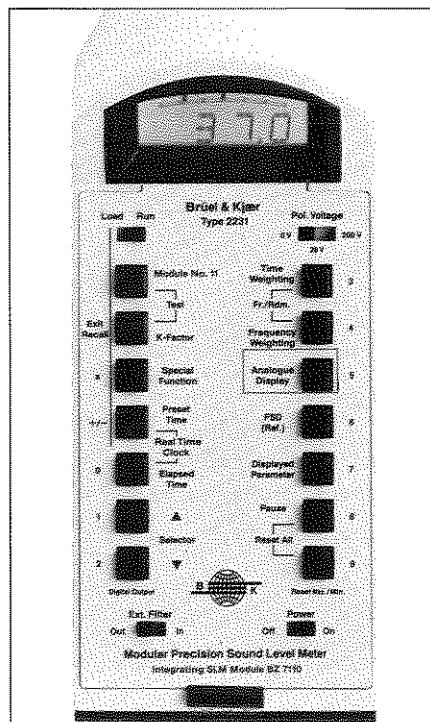

Note: Changing the display mode does not interrupt or affect the measurement in progress.

3.15. Special Functions

3.15.1. What are the Special Functions?

When programmed with Application Module BZ7110, Sound Level Meter Type 2231 has six special functions which modify the following facilities:

- Digital output of current measurement
- Storage of measurement records
- Digital output of measurement records
- Recall of measurement records to the display
- Change of internal parameters
- Erasure of measurement records

Each special function is defined by a certain code, consisting of an identifying prefix and definable digits (e.g. **S . 2 : 0 1** or **RE : 0 7**). These codes can be changed in two ways: manually (using the push-keys of the sound level meter) or from a computer (see section 4.3.2).

We shall now describe how to select a special function from the push-keys of the sound level meter. Then we shall describe what the special functions offer, and how you use them. A guide to the special functions is also printed on the back of the BZ7110's front plate.

3.15 Special Functions

3.15.2. Selecting a Special Function

1. Switch **Load/Run** to “**Run**”.
2. Press and hold **Special Function**.

The display shows the last displayed special function (S . 0 : 0 0 in the example).

3. Simultaneously press **Special Function** and **Selector ▲** or **Selector ▼** to select the special function that you want.

At the same time this also provides you with the opportunity to check the current status of the special functions.

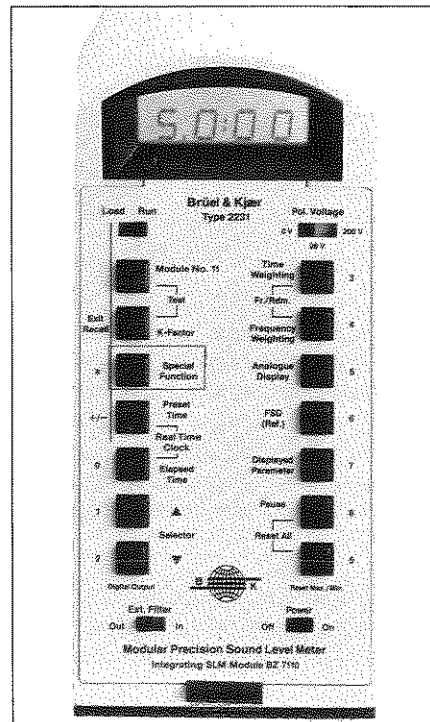

Note:

- Selecting a special function does not interrupt or affect the measurement in progress.
- When a module loads its program into the sound level meter, the **Special Functions** are set to zero.

3.15. Special Functions

3.15.3. Digital Output

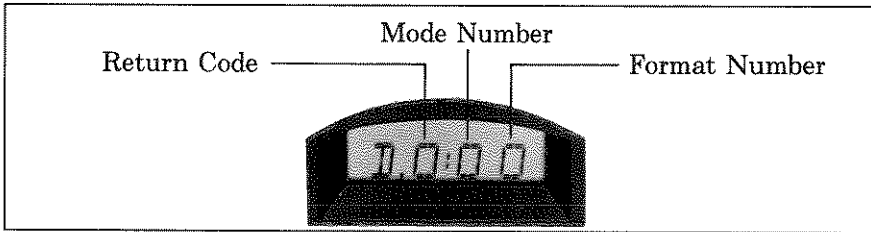

Fig. 3.1. Digital Output: display and codes

The Digital Output special function, identified by “D” followed by three digits (see Fig. 3.1), outputs measurement results which have been calculated during the current measurement period. Results are output via Interface Module ZI9101, to either Graphics Printer Type 2318, a standard RS-232 printer or a computer which has a RS-232 interface port and suitable communication software, such as BK-LINK version 2.0 (available from Brüel & Kjær) or similar.

Note:

- The Digital Output special function does not allow output of stored measurement results. This is done by using the Print Stored Record special function (see section 3.15.5).
- Output can be in one of eight formats and in one of six languages (English, German, French, Spanish, Italian, and Russian). To select a language, use the Special Code system function (see section 3.16.3).

3.15. Special Functions

Using "Digital Output":

1. Connect the sound level meter to either a printer (section 5.1) or a computer (section 4.2).
2. Select the Digital Output special function (see section 3.15.2).
3. Switch **Load/Run** to "**Load**".
4. Press **Special Function**.
5. Use pushkeys **0** to **9** to key in the desired Return Code, Mode Number and Format Number (described in the following pages).

The digits are shifted along the display from right to left, thereby allowing corrections to be made.

6. Switch **Load/Run** to "**Run**".

The sound level meter outputs measurement results which have been calculated during the current measurement period.

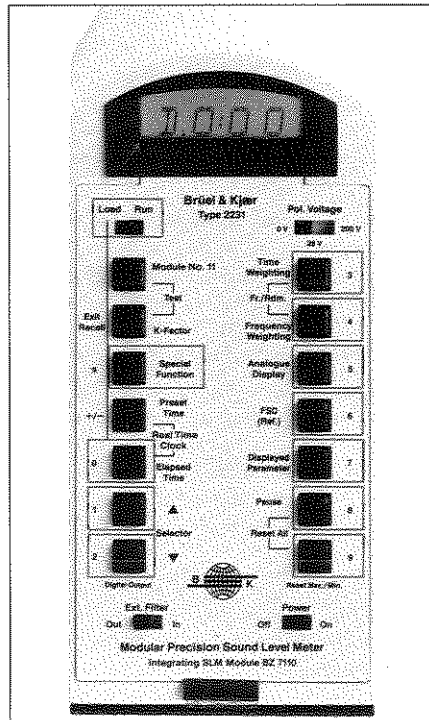

3.15. Special Functions

Digital Output - Return Code:

This digit (0 to 5) determines what will happen when the output is finished. The Return Code works only when you have selected Mode Number 2 or 3. Each digit, with a description of its effect when output is finished, is given below.

- 0: A new measurement starts.
- 1: The current measurement continues.
- 2: The sound level meter enters the pause condition.
- 3: For use with a computer: control of the sound level meter is transferred to the system monitor (see section 4.3.1). The system monitor is indicated by a prompt (:) on the screen of the computer terminal. The command **RC** (Enter) continues a measurement.
- 4: The same as Return Code 3, except that the command **RC** (Enter) enters the sound level meter into the pause condition and transfers control to the pushkeys of the sound level meter.
- 5: For use with a computer: control of the sound level meter is transferred to the BZ7110 monitor (see section 4.3.1). The system monitor is indicated by a prompt (*) on the screen of the computer terminal.

3.15. Special Functions

Digital Output – Mode Number:

This digit (1, 2 or 3) determines how digital output is started. Each digit, with a description of its effect, is given below.

1 : Manual Output – you can output results by doing the following:

1. Press **Pause**.
2. Press **Digital Output**.
The current measurement results are output.
3. Press **Pause** if you want to continue with the current measurement.
4. Press **Reset All** if you want to start a new measurement.

2 : Automatic Output – output starts automatically at the end of a preset measurement period (see section 3.9). The Return Code you select determines what happens after output is finished.

3 : Interface Control – prepares the sound level meter for externally controlled output of results upon activation of an external flag (B & K serial interface line “RD” (Received Data)). The signal should last 50 – 300 ms and be on high level: +5 V in the connected device (see section 5.2.3).

During measurements, the external flag can be activated from your computer keyboard by using the “Break” command (**not** the **<Break>** key). If you are using the BK-LINK or Procomm programs with the computer, do as follows to obtain the “Break” signal:

BK-LINK: press **<Space-bar>** until the output appears on the terminal screen.

Procomm: press **<Alt> <F5>**.

If you are using another program, see its instruction manual for information about the “Break” command.

After “Break”, control of the sound level meter is determined by the Return Code that you chose for the Digital Output.

3.15. Special Functions

Digital Output - Format Number:

This digit (1 to 9) defines the form of output data. Each digit, with a description of its corresponding output format, is given below.

- 1 : This gives a heading, space for remarks, a description of the sound level meter's set-up and a list of measurement results (see Fig. 3.2). For use with Graphics Printer Type 2318.
- 2 : As Format 1, but without the space for remarks. Also, the heading and the sound level meter's set-up are given in reduced form (see Fig. 3.3).
- 3 : As Format 2, but without the heading (see Fig. 3.4).
- 4 : Record Number, Date, Time, Set-up, and the MAXP, MAXL, MINL and L_{eq} results (see Fig. 3.5).
- 5 : The MAXP, MAXL, MINL and L_{eq} results (see Fig. 3.6).
- 6 : This format should be used with 80-character printers. It is suitable for presenting large numbers of data. With this format, 99 stored records can be printed on two A4 pages (see Fig. 3.7).
- 7 : This format is like Format 6, but does not have the heading (see Fig. 3.8).
- 8 : This format is designed for transferring data to a computer. It lets you choose which parameters you want to be transferred, and in which order they appear on the computer screen. The various values are separated by a character which you once again choose (e.g. a space or a comma). Section 4.3.3 describes Format 8 more fully.
- 9 : This is an "empty" format. Use it with the appropriate Return Code when you do not want an immediate output of results after a measurement has been completed.

3.15. Special Functions

```
BRUEL & KJÆR
MODULAR SLM TYPE 2231
-----
Record No.      00
Date            1992-02-10
Time            11:07:05
Remarks:
.....
.....
.....
.....
.....
SET-UP:
-----
Module #: 11 (BZ 7110)
Mic.Corr: + 0.0
S.I.Corr: "FRONTAL"
Pr. Time: 00:00:00
Time W. : "F"
Fres.W. : "A"
Rs. (dB): 30.0 - 103.0
MEASUREMENTS:
-----
MAXP           77.3 dB
MAXL           56.5 dB
MINL           32.7 dB
SEL            51.9 dB
LEQ            42.0 dB
Overload       00.00 %
Overrange      00.00 %
Underrange     00.00 %
Elapsed Time   00:00:10

Reset of Max/Min  N
No. of Interr.   0
802873/1
```

Fig. 3.2. Print-out in Format Number 1

3.15. Special Functions

```
-----  
B&K SLM TYPE 2231/B27110  
-----  
00 1992-02-10 11:07:05  
SET-UP: FFR  
  
MAXP      77.3 dB  
MAXL      56.5 dB  
MINL      32.7 dB  
SEL       51.9 dB  
LEQ       42.0 dB  
Overload  00.00 %  
Overrange 00.00 %  
Underrange 00.00 %  
Elapsed Time 00:00:10  
  
Reset of Max/Min      N  
No. of Interr.       0  
  
80207471a
```

Fig. 3.3. Print-out in Format Number 2

```
00 1992-02-10 11:07:05  
FFR  
MAXP      77.3 dB  
MAXL      56.5 dB  
MINL      32.7 dB  
SEL       51.9 dB  
LEQ       42.0 dB  
Overload  00.00 %  
Overrange 00.00 %  
Underrange 00.00 %  
Elapsed Time 00:00:10  
  
Reset of Max/Min      N  
No. of Interr.       0  
  
80207271a
```

Fig. 3.4. Print-out in Format Number 3

3.15. Special Functions

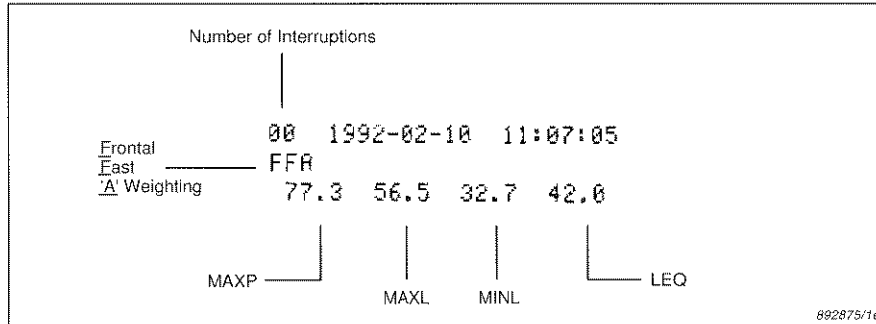

Fig. 3.5. Print-out in Format Number 4

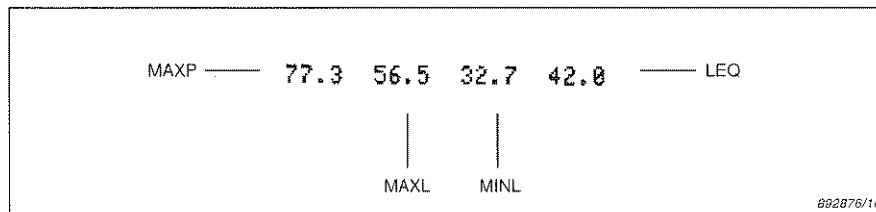

Fig. 3.6. Print-out in Format Number 5

3.15. Special Functions

| No | Date | Time | S-U | MAXP | MAXL | MINL | LEQ | E | DVL.: | DVR.: | UMR.: | CLA. | TIME |
|----|------------|----------|-----|-------|------|------|-------|-------|-------|-------|-------|----------|------|
| 01 | 1991-11-20 | 07:15:49 | FFA | 102.5 | 78.5 | 50.6 | 65.1 | 00.00 | 00.00 | 00.00 | 00.00 | 00:00:10 | |
| 02 | 1991-11-20 | 07:15:58 | FFA | 102.4 | 71.2 | 48.6 | 57.9 | 00.00 | 00.00 | 00.00 | 00.00 | 00:00:10 | |
| 03 | 1991-11-20 | 07:16:08 | FFA | 90.9 | 66.2 | 40.4 | 54.9 | 00.00 | 00.00 | 00.00 | 00.00 | 00:00:10 | |
| 04 | 1991-11-20 | 07:16:18 | FFA | 104.8 | 82.0 | 48.7 | 65.9* | 00.31 | 00.00 | 00.00 | 00.00 | 00:00:10 | |
| 05 | 1991-11-20 | 07:16:28 | FFA | 104.8 | 81.5 | 48.7 | 64.4* | 00.31 | 00.00 | 00.00 | 00.00 | 00:00:10 | |
| 06 | 1991-11-20 | 07:16:38 | FFA | 104.8 | 79.7 | 49.5 | 64.5* | 00.16 | 00.00 | 00.00 | 00.00 | 00:00:10 | |
| 07 | | | | | | | | | | | | | |

920347d

Fig. 3.7. Print-out in Format Number 6

| | | | | | | | | | | | | |
|----|------------|----------|-----|-------|------|------|-------|-------|-------|-------|-------|----------|
| 01 | 1991-11-20 | 07:15:49 | FFA | 102.5 | 78.5 | 50.6 | 65.1 | 00.00 | 00.00 | 00.00 | 00.00 | 00:00:10 |
| 02 | 1991-11-20 | 07:15:58 | FFA | 102.4 | 71.2 | 48.6 | 57.9 | 00.00 | 00.00 | 00.00 | 00.00 | 00:00:10 |
| 03 | 1991-11-20 | 07:16:08 | FFA | 90.9 | 66.2 | 48.4 | 54.9 | 00.00 | 00.00 | 00.00 | 00.00 | 00:00:10 |
| 04 | 1991-11-20 | 07:16:18 | FFA | 104.8 | 82.0 | 48.7 | 65.9* | 00.31 | 00.00 | 00.00 | 00.00 | 00:00:10 |
| 05 | 1991-11-20 | 07:16:28 | FFA | 104.8 | 81.5 | 48.7 | 64.4* | 00.31 | 00.00 | 00.00 | 00.00 | 00:00:10 |
| 06 | 1991-11-20 | 07:16:38 | FFA | 104.8 | 79.7 | 49.5 | 64.5* | 00.16 | 00.00 | 00.00 | 00.00 | 00:00:10 |
| 07 | 1991-11-20 | 07:16:48 | FFA | 87.2 | 68.6 | 48.2 | 54.8 | 00.00 | 00.00 | 00.00 | 00.00 | 00:00:10 |
| 08 | 1991-11-20 | 07:16:58 | FFA | 81.9 | 61.6 | 48.2 | 52.3 | 00.00 | 00.00 | 00.00 | 00.00 | 00:00:10 |
| 09 | | | | | | | | | | | | |

920346e

Fig. 3.8. Print-out in Format Number 7

3.15. Special Functions

3.15.4. Store Record

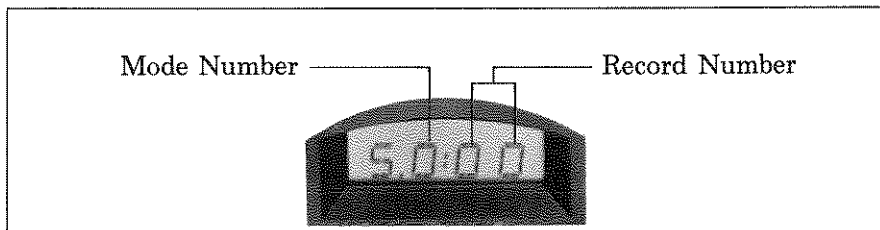
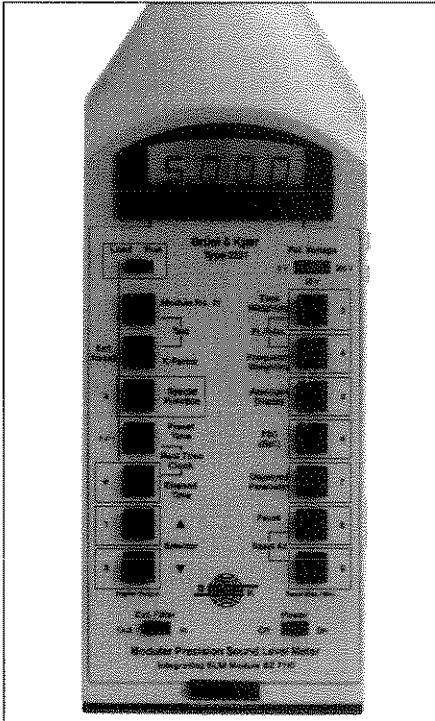

Fig. 3.9. Store Record: display and codes

The Store Record special function, identified by “S” followed by three digits (see Fig. 3.9), stores measurement results which have been calculated during the current measurement period. Up to 99 records can be stored.

3.15. Special Functions

Using "Store Record":



1. Select the Store Record special function (see section 3.15.2).
2. Switch **Load/Run** to "Load".
3. Press **Special Function**.
4. Use pushkeys **0** to **9** to key in the desired Mode Number and Record Number (described in the following pages).

The digits are shifted along the display from right to left, thereby allowing corrections to be made.

5. Switch **Load/Run** to "Run".

The sound level meter is now ready to store measurement results. The first record stored will be allocated the record number you keyed in (see step 4 above). For each new record stored, the record number automatically increases.

Note: The last record number used can be checked by pressing **Special Function** while Store Record is the displayed special function. For example, **S . 1 : 13** indicates that the last stored record was Record Number 13. This cannot be done, however, if you have used the **Exit Recall** pushkey (see section 3.15.6).

3.15. Special Functions

Store Record – Mode Number:

This digit (1, 2 or 3) determines how a measurement record is stored. Each digit, with a description of its effect, is given below.

1 : Manual Storage – you can store results by doing the following:

1. Press **Pause**.
2. Press **Digital Output**.
The current measurement results are stored.
3. Press **Pause** if you want to continue with the current measurement.
4. Press **Reset All** if you want to start a new measurement.

2 : Automatic Storage – records are stored automatically at the end of a preset measurement period (see section 3.9). A new measurement starts automatically, with no interruption of measurements.

3 : Interface Control – prepares the sound level meter for externally controlled storage of results upon activation of an external flag (B & K serial interface line “RD” (Received Data)). The signal should last 50 – 300ms and be on high level: +5 V in the connected device (see section 5.2.3).

During measurements, the external flag can be activated from your computer keyboard by using the “Break” command (**not** the **<Break>** key). If you are using the BK-LINK or Procomm programs with the computer, do as follows to obtain the “Break” signal:

BK-LINK: press **<Space-bar>** until the measurement is stored. This normally takes about 5 to 6 seconds (you can check to see if the record is stored by pressing the **Special Function** pushkey on the sound level meter – the record number will have increased by one).

Procomm: press **<Alt> <F5>**.

If you are using another program, see its instruction manual for information about the “Break” command.

After “Break”, the sound level meter goes on making measurements with no loss of data.

3.15. Special Functions

Store Record - Record Number:

These two digits identify a set of stored measurement results, so that you can recall and print stored records with the Recall to Display and Print Stored Record special functions (see sections 3.15.6 and 3.15.5 respectively). Up to 99 records can be stored, numbered from 01 to 99.

Every time a measurement is stored, the current Record Number automatically increases by one. Thus if, for example, you start with record number 01 and store five measurements, these are numbered 01 to 05. If you then use the Store Record special function to allocate number 20 to the next stored record (you might be making measurements in a different area) and then store ten records, these are numbered 20 to 29. If you then go back to your original measurement area, you can continue with the 01 to 05 series by allocating record number 06 to the next stored record. Measurements numbers then proceed as 06, 07, 08, etc.

In the above example, when the record number reaches 20, the new stored measurements 20 to 29 replace the measurements previously stored under these record numbers. So, when storing measurements, be careful that you are not overwriting important measurement records with other stored measurements.

To check the last record number used, display the Store Record special function (see section 3.15.4) or use the Recall to Display special function (see section 3.15.6), remembering that if a record number is not occupied, the S-U parameter will display **NORC**.

3.15. Special Functions

3.15.5. Print Stored Record

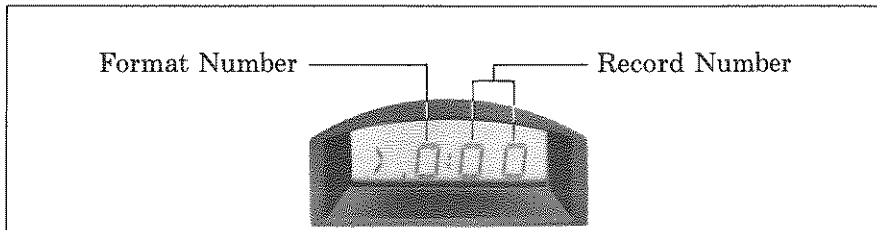

Fig. 3.10. Print Stored Record: display and codes

The Print Stored Record special function, identified by “}” followed by three digits (see Fig. 3.10), outputs stored measurement records. Results are output via Interface Module ZI91.01 to either Graphics Printer Type 2318, a standard RS-232 printer or a computer which has a RS-232 interface port and suitable communication software, such as BK-LINK version 2.0 (available from Brüel & Kjær) or similar.

Note: Output can be in one of eight formats and in one of six languages (English, German, French, Spanish, Italian, and Russian). To select a language, use the Special Code system function (see section 3.16.3).

3.15. Special Functions

Using "Print Stored Record":

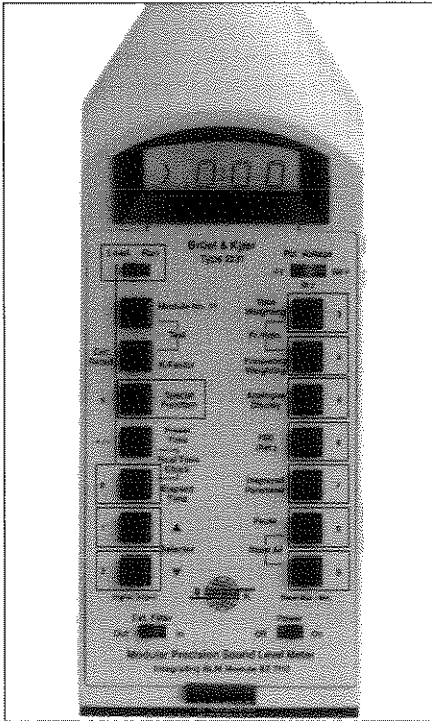

1. Connect the sound level meter to either a printer (section 5.1) or a computer (section 4.2).
2. Select the Print Stored Record special function (see section 3.15.2).
3. Switch **Load/Run** to "**Load**".
4. Press **Special Function**.
5. Use pushkeys **0** to **9** to key in the desired Format Number and Record Number (see the next page).

The digits are shifted along the display from right to left, thereby allowing corrections to be made.

6. Switch **Load/Run** to "**Run**".

The sound level meter outputs the record you keyed in (see step 4 above).

3.15. Special Functions

Print Stored Record – Format Number:

The Format Number codes, along with examples of the formats, are given in section 3.15.3.

Print Stored Record – Record Number:

The Record Number codes are given in section 3.15.4. If you want to output all stored measurement records, you should key 00 into the Record Number section of the display shown in Fig. 3.10.

3.15. Special Functions

3.15.6. Recall to Display

Note: If you are using the Recall to Display special function, always press **Exit/Recall** before you switch off the instrument. If you do not do this, the set-up of the sound level meter will be in an undefined state and normal operation will not be possible. If this happens, switch the sound level meter off and load the application module again (see section 2.5).

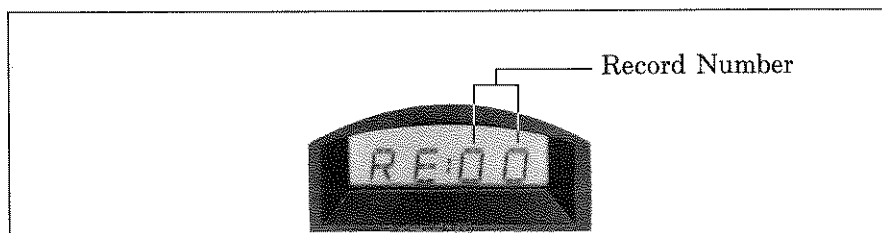

Fig. 3.11. Recall to Display: display and codes

The Recall to Display special function, identified by “RE” followed by two digits (see Fig. 3.11), recalls stored measurement records to the display of the sound level meter. Section 3.15.4 describes how to store measurements.

3.15. Special Functions

Using "Recall to Display":

1. Select the Recall to Display special function (see section 3.15.2).
2. Switch **Load/Run** to "**Load**".
3. Press **Special Function**.
4. Use pushkeys **0** to **9** to key in the desired Record Number.

The digits are shifted along the display from right to left, thereby allowing corrections to be made.

5. Switch **Load/Run** to "**Run**".

RE ## appears on the display, where "**##**" is the number of the record that you have chosen to recall. Note that **RE : 00** (if entered in step 4) is automatically corrected to **RE 01** in step 5, provided a record has been stored in record number **01**.

6. Press **Displayed Parameter**.

R No (Record No.) appears on the display.

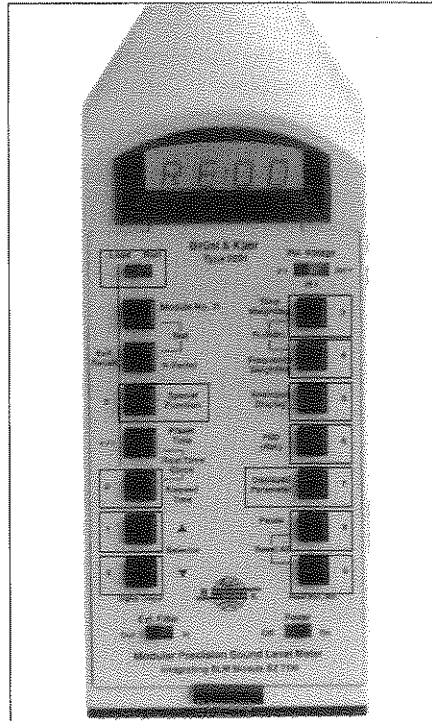

3.15. Special Functions

7. Simultaneously press **Displayed Parameter** and **Selector ▲** or **Selector ▼** to scroll through the names of the parameters contained in the selected record (see the next page).
8. Stop pressing the keys when you want to read the value of one of the parameters.
9. Press **Exit Recall** to exit the Recall to Display special function.

Note that when you press **Exit Recall**, the display for the Store Record special function (see section 3.15.4) returns to **S . 0 : 0 0**, though the records themselves remain stored under the same record numbers. Thus, the last stored record can thereafter be identified only by using the Recall to Display special function to check which record numbers contain measurement records (see note).

Note: While **RE##** is displayed, you can gain access to other record numbers by pressing **Selector ▲** or **Selector ▼**. This action increases or decreases the record number “##”. Stop pressing **Selector ▲** or **Selector ▼** when the display shows the number of the record that you want to recall to display.

3.15. Special Functions

The Parameters in a Record Recalled to the Display:

The following displays indicate what parameter value can be read as you scroll down (**Selector ▼**) through the contents of a record. Their meanings, and example values, are also given.

R No : Record Number (**RE01**)
ELT : Elapsed Time in hours and minutes (**02 : 30**)
TIME : Time at which record started (**10 : 00**)
LEQ : L_{eq} (**46 . 8**)
SEL : Sound Exposure Level (**56 . 8**)
UNR : Underrange for % of measurement time (**00 . 00**)
OVR : Overage for % of measurement time (**00 . 00**)
OVL : Overload for % of measurement time (**00 . 31**)
MINL : Min Level (**40 . 5**)
MAXL : Max Level (**58 . 5**)
MAXP : Max Peak (**81 . 5**)
S-U : Set-up code (**FFA**)

Note:

- If you are looking at the elapsed time (**ELT**) or the time at which a measurement started (**TIME**), you can view the seconds part of the display by pressing **S**.
- The set-up code (**S-U**) shows the time weighting, sound incidence correction and frequency weighting which were used during the measurement that you have recalled. In the example, the time weighting was **Fast**, the sound incidence correction was **Frontal**, and the frequency weighting was **"A"**. If you try to recall a record which does not exist, then the reply from **S-U** will be to display **NoRc** (no record).

3.15. Special Functions

3.15.7. Internal Parameters

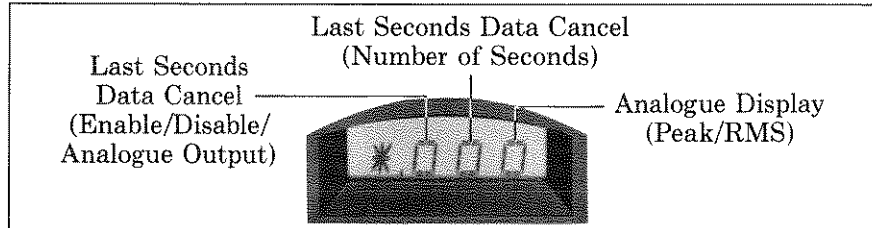

Fig. 3.12. Internal Parameters: display and codes

The Internal Parameters special function, identified by “*” followed by three digits (see Fig.3.12), lets the sound level meter do the following:

- Display either RMS or Peak values
- Ignore unwanted measurement data
- Output data in analogue form

3.15. Special Functions

Using "Internal Parameters":

1. Select the Internal Parameters special function (see section 3.15.2).
2. Switch **Load/Run** to "**Load**".
3. Press **Special Function**.
4. Use pushkeys **0** to **9** to key in the desired codes (see the following pages).

The digits are shifted along the display from right to left, thereby allowing corrections to be made.

5. Switch **Load/Run** to "**Run**".

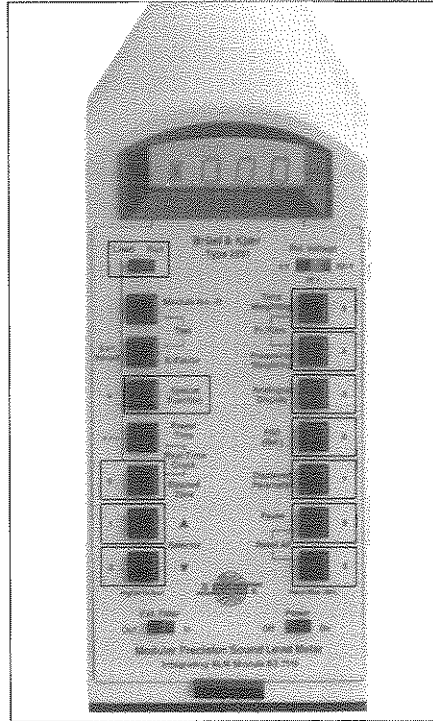

3.15. Special Functions

Internal Parameters – Last Seconds' Data Cancel (Enable/Disable/Analogue Output)

This digit (0, 1 or 2) determines whether the Last Seconds' Data Cancel or the Analogue Output special function is activated. Each digit, with its effect, is given below.

- 0 : Last Seconds' Data Cancel special function is not activated.
- 1 : Last Seconds' Data Cancel special function is activated.
- 2 : The Analogue Output special function is activated. This special function is for use with the sound level meter connected to Level Recorder Type 2317 (see section 5.4).

At the end of consecutive preset measurement periods, a voltage is transferred to the DC output of the sound level meter. This voltage is proportional to the L_{eq} for the measurement period in question, and is plotted on the Type 2317 (see Fig.3.13).

If there is an overload during a measurement period, the DC voltage increases by 5 V. This appears as an abrupt spike in the plot of the L_{eq} , and occurs immediately before the affected time period.

If there is no overload during a measurement period, the DC voltage drops to zero. This appears as an downward vertical line in the plot of the L_{eq} , and occurs immediately before the affected time period.

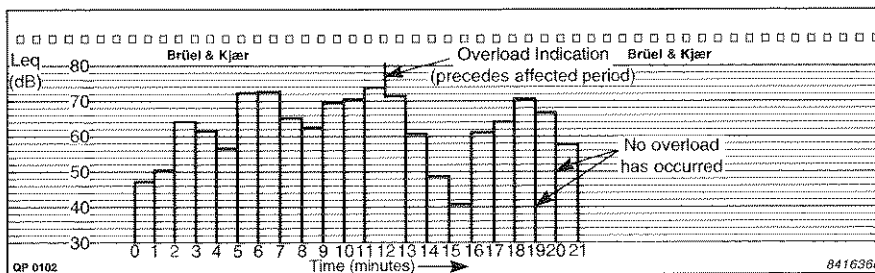

Fig. 3.13. Plot of L_{eq} vs. time. The paper speed on the 2317 Level Recorder is set to 1 mm/s and the Preset Time on the 2231 Sound Level Meter is set to 1 minute

3.15. Special Functions

Internal Parameters – Analogue Display:

This digit (0 or 1) determines whether the normal display (see section 3.14) shows RMS values or Peak values. Each digit, with its effect, is given below.

0 : RMS values displayed.

1 : Peak values displayed.

Internal Parameters – Last Seconds' Data Cancel (Number of Seconds)

This digit (0 to 9) determines the amount of data, in seconds, that the sound level meter excludes from measurement calculations.

If, for example, you key in “5”, the sound level meter does not take the last five seconds' data into account when calculating measurement results. If, however, you key in “0”, the sound level meter takes all measurement data into account. This function is especially useful if, when you are making a measurement, some unwanted sound occurs (for example, a barking dog).

Note: The Last Seconds Data Cancel special function works only if the pause condition is entered manually (i.e. when you press **Pause**). It does not work when the sound level meter enters the pause condition automatically (at the end of a preset measurement period).

3.15. Special Functions

3.15.8. Erase Store

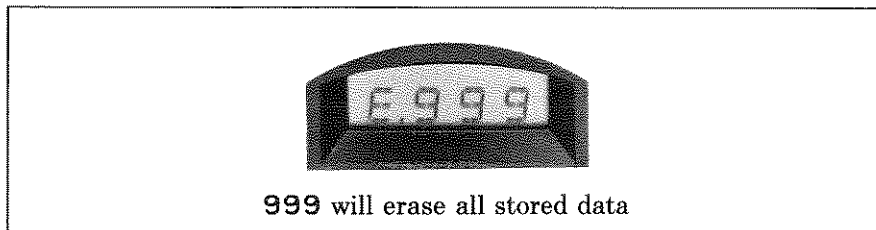

Fig. 3.14. Erase Store: display and codes

The Erase Store special function, identified by “E” followed by three digits (see Fig.3.14), erases all stored measurement records. The current record marker will be set to **01** upon starting a new record. Only the digits **9 9 9** have any effect. Before using this special function, preserve important measurement records by writing them down, printing them or transferring them to a computer.

3.15. Special Functions

Using "Erase Store":

1. Select the Erase Store special function (see section 3.15.2).
 2. Switch **Load/Run** to "**Load**".
 3. Press **Special Function**.
 4. Key in **9 9 9**.
 5. Switch **Load/Run** to "**Run**".
- All stored records are erased.

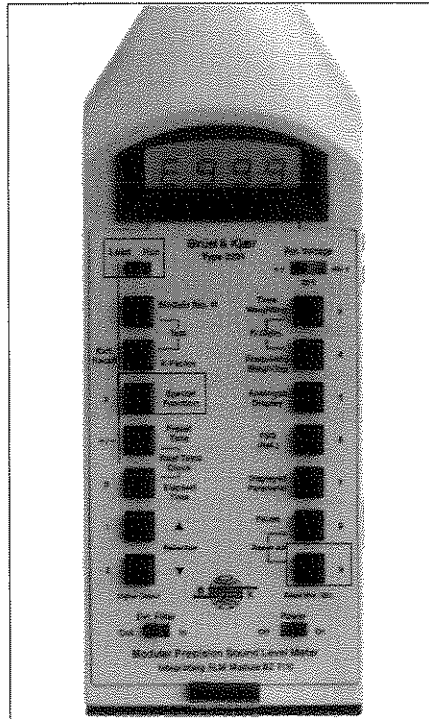

3.16. System Functions

3.16.1. What are the System Functions?

To understand the system functions, it is useful to equate a floppy disk with an application module, and a computer with a sound level meter. The disk delivers a particular program to the computer; the application module delivers a particular program to the sound level meter. The computer's in-built operating system ensures that the disk's program is loaded and working correctly; the sound level meter's in-built system functions ensure that the application module's program is loaded and working correctly. The system functions also control general service routines:

- Digital Interface routines
- Display routines
- Tables
- Clock/Calendar
- Generally used calculation routines

You can access, and change, some of the System Functions by using the pushkeys of the sound level meter. If you remove the front plate, you will see the logos referring to these System Functions, which let you do the following:

- SY - 1** : Show the communication monitor
- SY - 2** : Show the date and time
- SY - 3** : Change the date and time
- SY - 4** : Show the alarm: preset start time of measurement
(not used with Application Module BZ 7110)
- SY - 5** : Change the alarm: preset start time of measurement
(not used with Application Module BZ 7110)
- SY - 6** : Store a set-up
- SY - 7** : Select a communication monitor
- SY - 8** : Check and change the Special Code (choice of language for output text)
- SY - 9** : Restart the sound level meter

3.16. System Functions

3.16.2. Selecting a System Function

1. Remove the front plate from the sound level meter.
2. Switch **Load/Run** to “**Load**”.
3. Press **Enter/Exit**.

The display shows **S Y - 1**.

4. Use the pushkeys marked **1** to **9** to select the System Function that you want.

For example, if you want to use “**Special Code**”, press **8**, in which case **S Y - 8** would appear on the display.

5. Switch **Load/Run** to “**Run**”.

The display shows the desired system function.

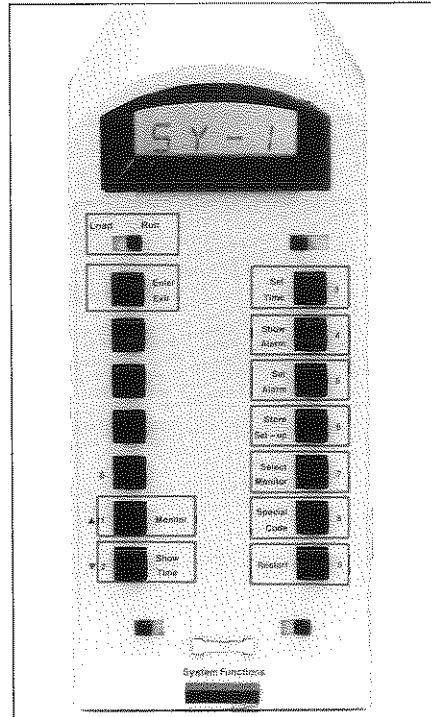

Note: Exiting **System Function** has the same effect as pressing **Reset All** (see section 3.11).

3.16. System Functions

3.16.3. The System Functions Themselves

Monitor (SY - 1):

Accesses the chosen monitor – see **Select Monitor (SY-7)**. The display shows **M - M o**, indicating that the sound level monitor is ready to communicate with a computer (see section 4.3.1). If you obtain this display by mistake, and have no computer with which to control the sound level meter, then switch off the sound level meter and turn it on to continue with your measurements.

Show Time (SY - 2):

Shows the date and time. The display automatically shows sequentially and continuously the year (**1 9 9 1**), the month and day (**0 7 . 1 0**), and the time in hours and minutes (**1 4 : 5 5**). Each display is shown for about one second. Press **Enter/Exit** to exit **Show Time**.

Set Time (SY - 3):

Lets you change the date and time. The display first shows the year (**Y Y Y Y**).

1. Use pushkeys **0** to **9** to key in the correct year (if the displayed year is correct, ignore this step).
The digits are shifted along the display from right to left, thereby allowing corrections to be made.
2. Press **Enter/Exit**.
The displays shows the month and day (**M M . D D**).
3. Follow the same procedure for the month and day and then for the time (**H H : M M**).
4. Press **Enter/Exit** to exit.

Show Alarm (SY - 4) and Set Alarm (SY - 5):

Not used with Application Module BZ 7110.

3.16. System Functions

Store Set-up (SY - 6):

When you load the sound level meter with a module, the parameter values revert to default settings (see section 2.5). These settings might not be the ones you use frequently. **Store Set-up** stores desired settings, and these will be the default values the next time you load the module, if you load it in a slightly different way – see below. Loading the module in the normal way, loads the normal default settings.

When you have selected **Store Set-up** (see section 3.16.2), the display shows **S-ST**, which means that the current parameter values are stored in the memory of the sound level meter. For Module BZ7110, the settings of the following parameters are stored:

- K-Factor
- Special Function
- Preset Time
- Time Weighting
- Frontal/Random
- Frequency Weighting
- Full Scale Deflection (FSD)
- Displayed Parameter

To obtain these settings whenever you load a module:

1. Switch **Load/Run** to “**Load**”.
2. Press **Module No. 11** and keep pressing it.
3. Switch **Load/Run** to “**Run**”.

Wait until **S-LO** appears on the display, confirming that the desired set-up has been loaded.

4. Stop pressing **Module No. 11**.

After a couple of seconds, the display will return to normal. The stored parameter values will now apply to your measurements.

3.16. System Functions

Select Monitor (SY - 7):

Use this function to check that you are using the correct interface monitor when interfacing the sound level meter with a computer. When you have chosen **Select Monitor**, the sound level meter displays **MO - #**, where “#” is either 0, 1 or 2 (**MO - 1** is the default display). The meaning of the numbers is as follows:

- MO - 0** : Alternative monitor (identical with monitor in earlier versions of the Type 2231)
- MO - 1** : Default monitor (the one you need)
- MO - 2** : External monitor (for future purposes)

If the display does not show **MO - 1**:

1. Press pushkey **I** to change the display to **MO - 1**.
2. Press **Enter/Exit**.

The display shows **W - M1**, confirming that you have chosen the correct monitor.

3. Press **Enter/Exit** again.

The display, after a couple of seconds, reverts to normal.

3.16. System Functions

Special Code (SY - 8):

This function defines the language of the text contained in output data. Six languages are available. An example Spanish print-out is shown in Fig. 3.15. Section 3.15.3 shows examples of print-outs in English.

After selecting **Special Code**, the display shows 0 0 0 0. This is the default code, and means that output text will be in English. Only the digit on the right is relevant. The remaining digits are for future use. The codes are as follows:

| | | |
|---------|---|---------|
| 0 0 0 0 | : | English |
| 0 0 0 1 | : | German |
| 0 0 0 2 | : | French |
| 0 0 0 3 | : | Spanish |
| 0 0 0 4 | : | Italian |
| 0 0 0 5 | : | Russian |

Selecting the language of a print-out

1. Use pushkeys **0** to **5** to key in the special code you want (use four numbers: for example to obtain a French output, press **0 0 0 2**).

The digits are shifted along the display from right to left, thereby allowing corrections to be made.

2. Press **Enter/Exit**.

The display will revert to normal.

Note:

- If the right hand number in the special code is greater than **5**, the output text will automatically be in Russian.
- The transferred codes are standardized national 7-bit codes. For each output format, the transmission starts with control codes so as to establish the proper code tables in Graphics Printer Type 2318 (see section 5.1).

Restart (SY - 9):

This function tests the display before resetting all displayed parameters (see sections 3.1 and 3.11). The function also offers a quick way of exiting the System Functions if you have entered them by mistake.

3.16. System Functions

```
BRUEL & KJÆR
SONOMETRO MODULAR DE
PRECISION MODELO 2231
-----

no. de res.:      0000
Fecha             1991-06-18
hora              11:04:34
Observaciones:
.....
.....
.....
.....
.....

CONFIGURACION:
-----
Mo'dulo #: 15 (B2 7115)
Corr.Mic: + 0.0 dB
Incidenc: "FRONTAL"
Hora Pr.: 00:00:10
Pd.Temp.: "F"
Pd.Frec.: "A"
Gama(dB): 40.0 - 113.0

MEDIDAS:
-----
MAXP              112.4 dB
MINL              56.2 dB
LEQ               76.2 dB
SEL               86.2 dB

Sin saturacio'n

Tiempo Trans: 00:00:10
no. de Interr.: 0
912245e
```

Fig. 3.15. Spanish print-out in Format Number 1

3.17. An Example Measurement

3.17.1. Introduction

This section guides you through a typical measurement using Integrating SLM Module BZ7110. Before you start, do the following:

1. Load the module with Module BZ7110.
2. Mount the BZ7110 front plate on the sound level meter.
3. Set the **Load/Run** switch to “**Run**”.
4. Set the **Pol. Voltage** switch to “**0V**”.
5. Set the **Ext. Filter** switch to “**Out**”.
6. Set the **Power** switch to “**On**”.

3.17.2. The Measurement Procedure

We shall now go through a simple measurement procedure, covering the following objectives:

- Changing certain measurement parameters.
- Scrolling through the displayed parameters.
- Storing records automatically.
- Entering a preset time.
- Starting a series of measurements.
- Recalling measurement records to display.
- Stopping measurements.

3.17. An Example Measurement

Changing Measurement Parameters

1. Press **FSD**.
The display shows 120.0, which is the default FSD.
2. Press **Selector ▼** once while pressing **FSD**.
The display shows 110.0.
3. Repeat step 2 and stop pressing **FSD**.
You have now changed the FSD to 100.0.
4. Press **Frequency Weighting**.
The display shows A, which is the default Frequency Weighting.
5. Press **Selector ▼** once while pressing **Frequency Weighting**.
The display shows C. You have now changed the Frequency Weighting to "C".

Scrolling Through Displayed Parameters

6. Press **Displayed Parameter**.
The display shows SPL, which is the default Displayed Parameter.
7. Press **Selector ▼** once while pressing **Displayed Parameter**.
The display shows LEQ.
8. Stop pressing **Displayed Parameter**.
The display shows the current L_{eq} .
9. Repeat steps 7 and 8 for all the displayed parameters through to **PEAK**, and then return to **SPL**.
There are eleven displayed parameters in all.

3.17. An Example Measurement

Storing
Measurements
Automatically

10. Press **Special Function**.
The display shows **D . 0 : 0 0**, which is the default Special Function.
11. Press **Selector ▲** once while pressing **Special Function**.
The display shows **S . 0 : 0 0** for a couple of seconds. This is the Store Record special function.
12. Switch **Load/Run** to “**Load**”.
13. Press **Special Function**.
The display shows and continues to show **S . 0 : 0 0**.
14. Press **2** then **0** then **1**.
The displays shows **S . 2 : 0 1**. This means that a measurement will be automatically stored at the end of a preset measurement period (Mode 2 in the display), and that the first record will be record number 1 (**0 1** in the display).
15. Switch **Load/Run** to “**Run**”.

Entering a
Preset
Time

16. Press **Pause**.
17. With **Load/Run** switched to “**Run**”, press **Preset Time**.
The displays shows **0 0 : 0 0**, indicating that the Preset Time is currently **00 hours 00 minutes**.
18. Press and keep pressing **s**.
The display shows **0 0**, indicating that the seconds part of the Preset Time is also **00**.
19. Press **3** then **0**.
The display shows **3 0**, indicating that the seconds part of the Preset Time is **30**.

3.17. An Example Measurement

20. Stop pressing **s**.
21. Switch **Load/Run** to **"Run"**.
You have set the Preset Time to **30 seconds**.
- Starting
Measurements
22. Press **Reset All**.
The sound level meter starts making measurements. The value on the display is the SPL, which you chose as the displayed parameter in step 9.
23. Press **Preset Time** and **s** to check the Preset Time.
24. Press **Elapsed Time** and **s**.
The display shows the "seconds" counter.
25. Stop pressing **Elapsed Time** and **s**.
At the end of every thirty seconds, the sound level meter will store its measurement results. A new measurement begins every thirty seconds, with no loss of data between measurement periods. The record number of the first record will be **01**, that of the next **02**, and so on, automatically increasing by one. The maximum number of records that can be stored is 99. We recommend that you let the sound level meter store measurements for ten minutes.
- Recalling
Records to
Display
26. Press **Pause** at the end of the ten minutes.
27. Press **Special Function**.
The display shows **S . 2 : 21**, indicating that the mode number is **2** and that the next record number to be stored will be number **21**. Twenty records have thus been stored (two each minute for ten minutes).

3.17. An Example Measurement

28. Press **Selector ▲** twice while pressing **Special Function**.
The display shows **RE : 00**. The space occupied by "00" is the number of the record that you want to recall to display.
29. Switch **Load/Run** to "Load".
30. Press **Special Function**.
31. Press **0** then **1** to recall record number **01**.
32. Switch **Load/Run** to "Load".
33. Press **Displayed Parameter**.
The display shows **R No** (Record Number). So the current displayed parameter is the record number: in this case, record number **01** (**RE : 01**).
34. Use the **Selector ▼**, **Selector ▲** and **Displayed Parameter** pushkeys to locate a particular displayed parameter.

The parameters that can be viewed with the Recall to Display special function are as follows (in "downward" order, using **Selector ▼**):

| | |
|--------------|---|
| R No | : Record Number |
| ELT | : Elapsed Time |
| TIME | : Measurement start time |
| LEQ | : L_{eq} |
| SEL | : Sound Exposure Level |
| UNR | : Underrange % |
| OVER | : Overrange % |
| OVL | : Overload % |
| MINL | : Minimum sound level |
| MAXL | : Maximum sound level |
| MAXP | : Maximum peak level |
| S - U | : Set-up (e.g. F ast F rontal " A ") |

3.17. An Example Measurement

35. Use the **Selector ▼**, **Selector ▲** and **Displayed Parameter** pushkeys to display **R No.**
36. Use the **Selector ▲** to obtain other record numbers, and recall their contents to display by following step 34.
37. Press **Exit Recall** when you are finished with the Recall to Display special function.
The display returns to the pause condition, as it was just after step 26.
38. Switch **Power** to **"Off"**.

3.18. Display Messages

- M-E 1** **No application module inserted:**
No module inserted and no application software in sound level meter memory during attempted loading of module.
- M-E 2** **Application module software not yet stored:**
No application software stored in the sound level meter memory.
- M-E 3** **Error in software copy:**
The application software stored in the sound level meter contains an error. Re-load with Integrating SLM Module BZ7110.
- M-E 4** **External monitor not suitable:**
Communication monitor (MO - 2) chosen - this monitor is reserved only for future purposes. Choose communication monitor MO - 1.
- M-E 5** **Back-up battery low:**
Not enough power in back-up battery for sound level meter memory (see section 2.2). Reset certain parameters (e.g. the Real Time Clock and the selected Monitor) as indicated on the display.
- M-M 0** **Monitor:**
Monitor program is enabled and sound level meter is set up to communicate across the interface.

3.18. Display Messages

- M-11** **Application module number:**
Shows identifying number of the application software at the end of a successful loading, or when you press “**Module No. 11**” while the **Load/Run** switch is set to “**Run**”.
- M---** **Ready to load module software:**
No application software stored in the sound level meter memory. Sound level meter ready to receive software from the inserted application module.
- MO-1** **Monitor number:**
Displayed when you use **Select Monitor System Function**.
- O---** **Overrange:**
The level of the sound reaching the sound level meter is above the current measuring range. Set FSD accordingly.
- REF** **Reference signal activated:**
The internal reference signal, 94 dB at 1000 Hz, is activated. To deactivate it, select an appropriate FSD.
- S-LO** **Current set-up loaded:**
Stored set-up successfully loaded.

3.18. Display Messages

| | |
|--------------------|---|
| S-ST | Store set-up: Current set-up has been stored in the memory of the sound level meter. |
| U_ _ _ | Underrange: The level of the sound reaching the sound level meter is below the current measuring range. Set FSD accordingly. |
| W-M1 | Confirmation of monitor number: Confirmation of communication monitor after selection with Select Monitor System Function. |
| B A T | Battery low: Flashing "BAT" appears in the display. With alkaline batteries approximately 30 min operation remaining. |
| B A T plus ↑ | Battery too low for accurate operation: Flashing "BAT" with constant ↑. Replace batteries. |
| **** | Selected value outside allowed range: The requested parameter is outside the allowed range. For example Preset Time > 99 h 59 min 59 s. |
| ↑ | Overload occurring: The level of the sound reaching the sound level meter is overloading the instrument's circuits. |
| ▲ | Overload has occurred: The instrument's circuits have been overloaded during the measurement (i.e. since the last Reset All). |

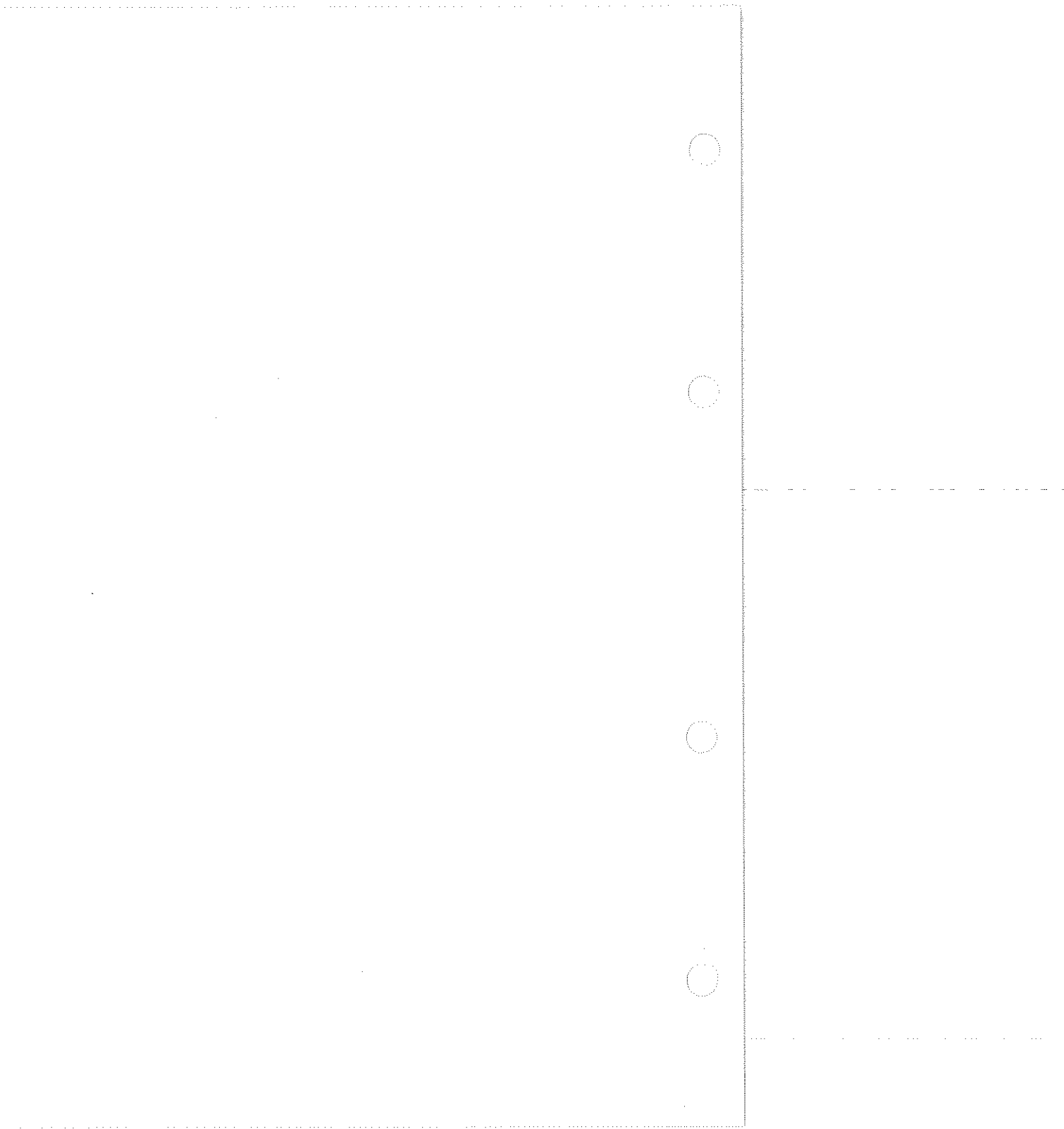

4.1. Introduction

The software in Module BZ7110 contains a communication monitor which lets you control the sound level meter from a computer, using simple commands. The communication monitor also checks for errors in syntax and range, and will inform you of these.

To interface the Type 2231 and a computer, you need a computer which has a RS-232 interface port and suitable communication software: BK-LINK version 2.0 (available from Brüel & Kjær), Procomm or similar. To connect the sound level meter and the computer, you need Interface Module ZI9101 and Interface Cable AO0335 (see Fig. 4.1). Interface Module ZI9101 allows communication at baud rates of 110, 150, 300, 600, 1200, 2400, 4800 or 9600. The sound level meter's default monitor MO - 1 can handle any of these rates (see section 5.2.2).

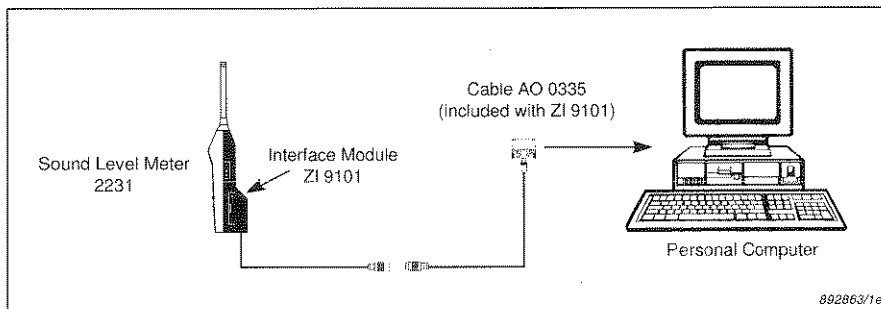

Fig. 4.1. The Type 2231 connected to a computer

Note: The Type 2231 can “echo” the command signals, but only if the alternative monitor MO - 0 is used. The alternative monitor can handle baud rates of up to 1200.

4.2. Connecting a Computer to the Sound Level Meter

WARNING! When connecting the sound level meter equipment to a computer, switch both pieces of equipment **off**. If you do not do this, the equipment could get damaged.

1. Set the Interface Module ZI9101 switches to their desired position (see section 5.2).
2. Insert the interface module into the interface socket at the back of the sound level meter.
3. Insert the interface module's 5-pin plug into the 5-pin socket on Interface Cable AO0335, making sure that the red dots on the plug and socket are aligned.
4. Connect the 25-pin plug on AO0335 to the communications port at the back of the computer.
5. Check the **Monitor** system function (see section 3.16.3) to make sure that you are using the correct communication monitor (**MO - 1**).
6. Configure the computer software as follows:

| | |
|-----------|-------------------------|
| COM | : 1 (if Port 1 is used) |
| Baud Rate | : as on ZI9101 |
| DataBits | : 8 |
| Parity | : None |
| StopBits | : 1 |

4.3. Using the BZ 7110 Communication Monitor

4.3.1. Starting the Monitor

1. Switch **Load/Run** to “**Load**”.

2. Press **Module No. 11**.

The display shows **SY - 1**.

3. Switch **Load/Run** to “**Run**”.

The display shows **M - Mo**, and the computer screen shows:

2 2 3 1 M O N I T O R

:

This indicates that the System Monitor is in operation.

4. Type **P** (<**Enter**>) on the computer keyboard (the “**P**” must be upper case).

An asterisk appears on the computer screen:

*

This indicates that the BZ7110 monitor is in operation. You can now control the sound level meter from the computer keyboard. The commands needed to do this are given in Table 4.1.

4.3. Using the BZ 7110 Communication Monitor

Note:

- The screen error message **ERR - S** indicates a syntax error (you have incorrectly keyed in a command). The screen error message **ERR - R** indicates a range error (the values you have requested are outside the range of the instrument). In both cases, respond by entering the correct command. **ERR - R** can also appear if the sound level meter is not sufficiently powered by its batteries. In this case, disconnect the sound level meter from the computer, and insert new batteries.
- If communication between the sound level meter and the computer fails, check that:
 - all cable connections are secure
 - the software is properly configured (see section 4.2)
 - the baud rate on Interface Module ZI9101 matches that in the software configuration (see sections 4.2 and 5.2.2)
 - you are working with the BZ 7110 communication monitor, MO-1 (see section 3.20.3 for **Select Monitor**)

If communication failure persists, contact your local Brüel & Kjær representative.

4.3. Using the BZ 7110 Communication Monitor

4.3.2. BZ7110 Monitor Commands

_ = Type a space
= Type a number
< Enter > commands

| Abbreviated Command | Function | Response |
|---------------------|---|-----------------------------------|
| B | Battery Test | OK, OK-NII or ERR-B (Note 1) |
| EL | Read Elapsed Time | HH:MM:SS |
| ERA | Erase Store | ★ (Note 2) |
| EXL | External Filter Linear | ★ (Note 3) |
| EXS | External Filter Step | ★ (Note 4) |
| FA | Set Frequency Weighting "A" | ★ |
| FC | Set Frequency Weighting "C" | ★ |
| FI | Set Frequency Weighting "I" | ★ (Note 5) |
| FL | Set Frequency Weighting "L" | ★ (Note 6) |
| K_ ± ### | Set Microphone K-Factor | ★ |
| L_# | Read L_{eq} | Value |
| MAP | Read Max. Peak Level | Value |
| MI | Read Min. RMS level | Value |
| ML | Read Max. RMS Level | Value |
| PA | Pause Counter | Number of pauses |
| PR_###:### | Set Preset Time | HH:MM:SS |
| R | Run (start measurement) | |
| RC | Run Continue (continue measurement) | |
| RCP | Run Continue Pause | Note 7 |
| RE_#_# | Recall Record Format No.# and Record No.## | Chosen record in chosen format |

T03366GB0

Table 4.1.(1) BZ7110 Monitor Commands

4.3. Using the BZ7110 Communication Monitor

_ = Type a space
= Type a number
< Enter > commands

| Abbreviated Command | Function | Response |
|------------------------|---|---------------------------|
| RG_# | Set Measuring Range | ★ (Note 8) |
| SE | Read Sound Exposure Level | Value |
| SIF | Set Sound Incidence Frontal | ★ |
| SIR | Set Sound Incidence Random | ★ |
| SPF_D### | Set Special Function: Digital Output | ★ |
| SPE_D### | Set Special Function: Digital Output | ★ |
| SPF_S### | Set Special Function: Store Record | ★ |
| SPE_S### | Set Special Function: Store Record | ★ |
| SPF_ * ### | Set Special Function: Internal Parameters | ★ |
| SPE_ * ### | Set Special Function: Internal Parameters | ★ |
| T(##.#.#...#.#.#/#) | Set Template for Format 8 | See Template command list |
| TF | Set Time Weighting Fast | ★ |
| TI | Set Time Weighting Impulse | ★ |
| TS | Set Time Weighting Slow | ★ |
| TY_# | Output Format # (Working Area) | Note 9 |
| WR | Read Real Time Clock (Watch Read) | YYYY-MM-DD HH:MM:SS |
| WW_YYYY-MM-DD_HH:MM:SS | Set Real Time Clock (Watch Write) | YYYY-MM-DD HH:MM:SS |

T03367GB0

Table 4.1.(2) BZ7110 Monitor Commands

4.3. Using the BZ7110 Communication Monitor

Note 1: **NLL** means "Near Low Level". **ERR-B** means that the battery is not supplying enough power for operation.

Note 2: The **ERA** **<Enter>** command erases **all** stored records. When you use this command, the computer asks if you are sure that you want to erase the records (**SURE Y/N?**). Press **<Y>** **<Enter>** to erase all records. Press **<N>** **<Enter>** if you do not want to erase the records. In both cases, the BZ7116 monitor prompt ("*") will return to the screen.

Note 3: For use with $\frac{1}{3}$ - $\frac{1}{4}$ Octave Filter Set Type 1625: moves the centre frequency on the filter set one step up.

Note 4: For use with $\frac{1}{3}$ - $\frac{1}{4}$ Octave Filter Set Type 1625: moves the centre frequency on the filter to Lin.

Note 5: The lower case "l" in the command sets the Frequency Weighting to Linear.

Note 6: The upper case "L" in the command sets the Frequency Weighting to All Pass.

4.3. Using the BZ 7110 Communication Monitor

Note 7: The **RCP** **<Enter>** command enters the sound level meter into the pause condition and transfers control to the pushkeys of the sound level meter.

Note 8: The “#” in **RG_#** indicates the following (also see section 3.7, Table 3.1):

RG0..... 60 dB FSD*
RG1..... 70 dB FSD*
RG2..... 80 dB FSD*
RG3..... 90 dB FSD*
RG4.....100 dB FSD*
RG5.....110 dB FSD*
RG6.....120 dB FSD*
RG7.....(REF) Internal reference signal

* Plus currently selected K-Factor

Note 9: The **TY_#** **<Enter>** command reads out data from the working area in the memory – that is, the last measured results or the last stored results will be read out. The data will be in format “#” (where # = 1 to 8)

4.3.3. Format 8

Format 8 (see section 3.15.3) lets you define what parameters will be output from the sound level meter, and in what order they will be output. You can also choose how these parameters should be separated, useful in formatting data for different types of spreadsheet program. Each of the available parameters is allocated a number, as shown in Table 4.2.

4.3. Using the BZ7110 Communication Monitor

| # | Data | # | Data |
|----|------------------------|----|---|
| 1 | Record No. ## (Note 1) | 13 | MinL |
| 2 | — | 14 | SEL or IEL Indicator (Note 2) |
| 3 | Date (YY-MM-DD) | 15 | SEL or IEL Value |
| 4 | Time (HH:MM:SS) | 16 | L _{eq} or L _{im} Indicator (Note 3) |
| 5 | Microphone K-Factor | 17 | L _{eq} or L _{im} Value |
| 6 | Frontal/Random | 18 | Error (★ = Error) |
| 7 | Preset Time (HH:MM:SS) | 19 | Overload |
| 8 | Time Weighting | 20 | Overrange |
| 9 | Frequency Weighting | 21 | Underrange |
| 10 | Measuring Range | 22 | Elapsed Time (HH:MM:SS) |
| 11 | MaxP | 23 | Pause Counter |
| 12 | MaxL | | |

T03368GB0

Table 4.2. Number codes used in Format 8

After you have defined and entered **<Enter>** the parameters for Format 8, your choice for this format will be retained until the BZ7110 module is re-loaded. To check the contents of Format 8, use the **TY_ 8 <Enter>** command (see table 4.1).

Note 1: The record number of the data in the working area – the last measured results or the last stored results.

Note 2: “SEL” with Slow and Fast time weightings. “IEL” with Impulse time weighting. See section 3.8.

Note 3: “L_{eq}” with Slow and Fast time weightings. “L_{im}” with Impulse time weighting.

4.3. Using the BZ7110 Communication Monitor

Using the Numbered Codes in Format 8:

When you use Format 8, note the following points. They refer to the ways in which you can detail the parameters you want to be contained in the output.

Typing in the numbers:

If you type:

```
T(3,4,5,6,11,16) <Enter>
```

the following parameters appear (see Table 4.2):

```
Date Time K-Factor Frontal/Random MaxP Leq
```

Using a dash:

If you type :

```
T(3-6,11,16) <Enter>
```

exactly the same parameters appear, so you can use a dash to indicate that all numbers between two numbers should be included in the template (i.e. "3-6" = "3,4,5,6").

The order of the numbers:

If you type :

```
T(16,11,6-3) <Enter>
```

you obtain the same parameters in reverse order; so the order in which you type the numbers determines the order in which the parameters appear on the computer screen.

Note: If you load Application Module BZ7110 and then use Format 8 without defining the parameters in the template, the following four parameters are output: **MaxP**, **MaxL**, **L_{eq}** and **Elapsed Time**. Thus, the default Format 8 corresponds to (12, 15, 17, 22) – see Table 4.2. The parameters will be separated by a comma.

4.3. Using the BZ 7110 Communication Monitor

Separating the data in Format 8:

If you type / , at the end of the list of parameters:

T(3,4,5,6,11,16/) <Enter>

the parameters are separated by a comma:

Date , Time , K-Factor , Frontal/Random , MaxP , L_{eq}

The default data-separator is a space, which is obtained if you do not include "/" at the end of your template list (as in the three examples on the previous page). Other data separators are given in Table 4.3.

| Data-separator | Effect |
|----------------|-------------------------------------|
| None (default) | A space between data |
| Character | Chosen character will separate data |
| 0 | "CR" + "LF" |
| 1 | "CR" |

T03397GB0

Table 4.3. Data Separators

If you therefore type :

T(3,4,16,11/0) <Enter>

the parameters are transmitted and/or displayed as follows:

Date
Time
L_{eq}
MaxP

Note: "CR" means Carriage Return. "CR + LF" means Carriage Return and Line Feed (each item of data is on a separate line, as in the example above).

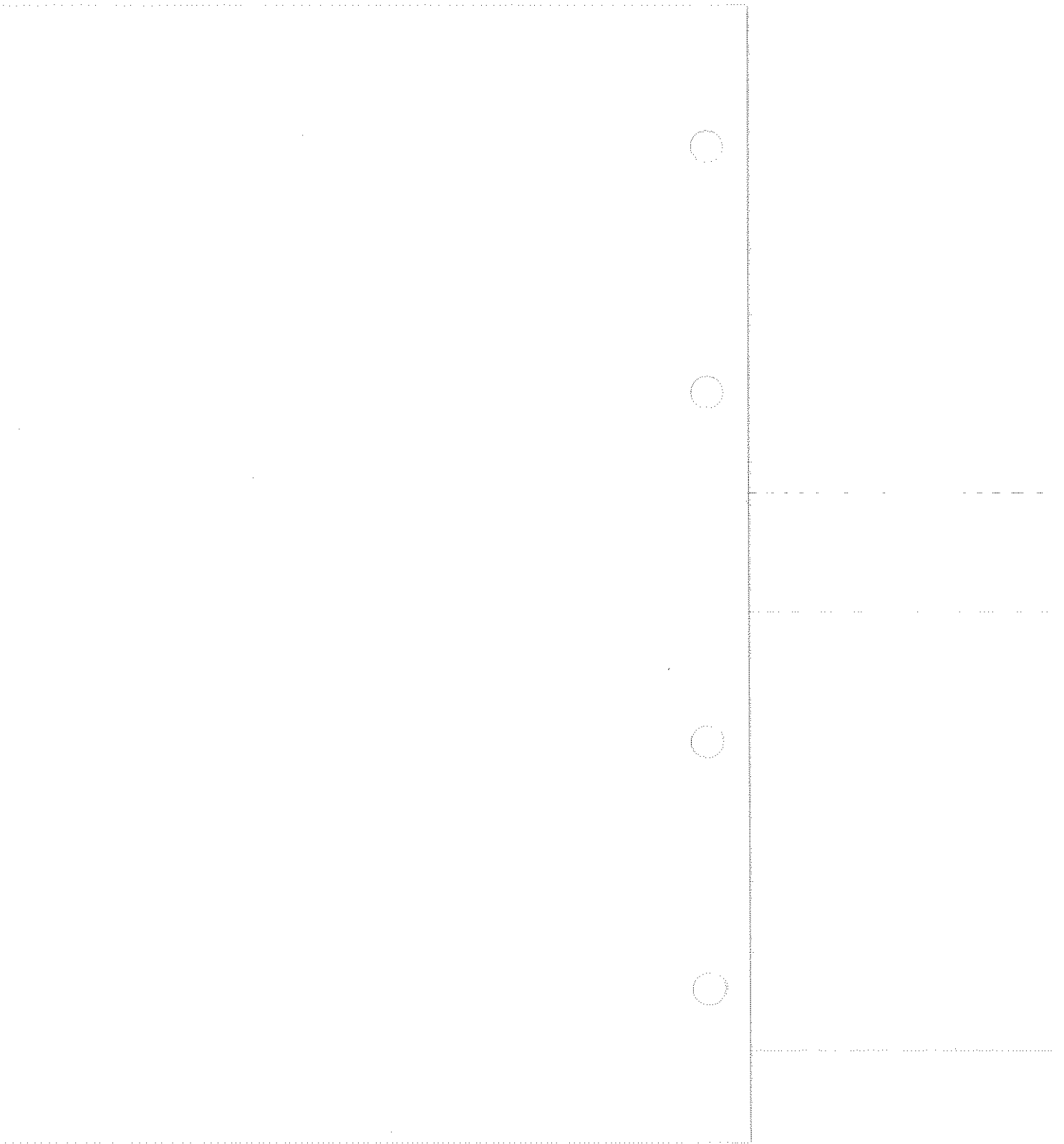

5.1. Graphics Printer Type 2318

The Graphics Printer Type 2318 is a compact, battery-operated printer for generating on-the-spot records of measurements. With its supplied Interface Module ZI0054 it offers tabular and graphical print-outs of data sent to it from measuring instruments with a RS-232 serial interface.

The Type 2318 (with Module ZI0054) is particularly well suited for use with the Modular Precision Sound Level Meter Type 2231. Both can be hand-held yet, when used together, produce all the data, storage facilities and documentation that you need. For details on how to use Graphics Printer Type 2318, see its instruction manual. Fig.5.1 shows the sound level meter connected to the graphics printer via Interface Module ZI9101.

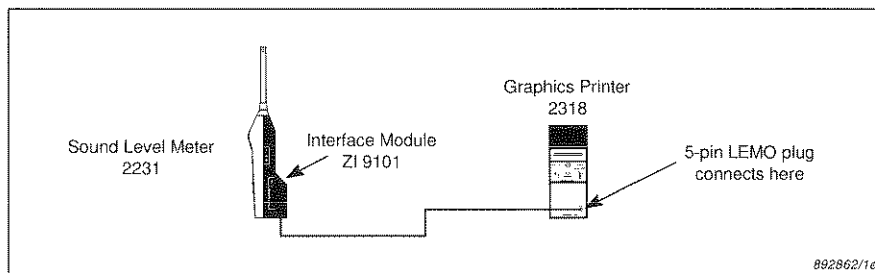

Fig. 5.1. The Type 2231 connected to Graphics Printer Type 2318

5.1. Graphics Printer Type 2318

With Module BZ7110, data can be output to the Type 2318 in five formats. See section 3.15.3 for examples of these formats in English.

With the Type 2318 you can also obtain print-outs in German, French, Spanish, Italian and Russian. This requires you to change the Special Code system function (section 3.16.3 gives details about this, and also shows an example print-out in Spanish).

5.2. Interface Module ZI9101

WARNING! Switch off the sound level meter and all other instruments before connecting Interface Module ZI9101. If you do not do this, electrical damage to the instruments could result.

5.2.1. Interface Module Description

Interface Module ZI9101 (see Fig. 5.2) lets the Type 2231 communicate with other devices which have a RS-232 serial interface (for example, Graphics Printer Type 2318 or a personal computer). It conforms to the Brüel & Kjær Serial Interface Standard (B & K-SI) and connects to the back of the sound level meter in the same way as Integrating SLM Module BZ7110.

The interface module is fitted with a 5-pin plug, which is intended for use with Graphics Printer Type 2318 (see section 5.1 and the instruction manual for the Type 2318) and other compatible printers. Supplied with the interface module is an Interface Cable AO 0335, which lets the interface module be connected to a female 25-pin D-type connector, which is commonly found on equipment that has a RS-232 or V24 interface. Chapter 4 gives more details on using the sound level meter with a computer.

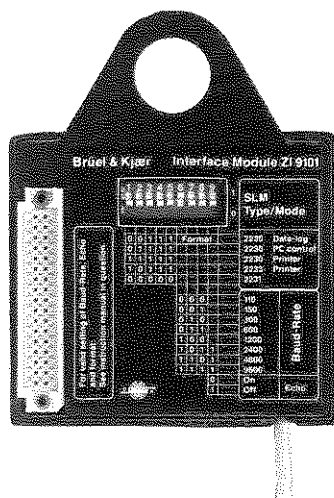

Fig. 5.2. Interface Module ZI9101

5.2. Interface Module ZI9101

5.2.2. Baud Rate Settings

The rear of the interface module has a small multi-switch with a printed guide to the baud rate settings. Fig. 5.3 shows the switch setting for the Type 2231 and a baud rate of 1200 baud without echo (the interface module will have this setting when you receive it from the factory). All switch settings are listed in Table 5.1.

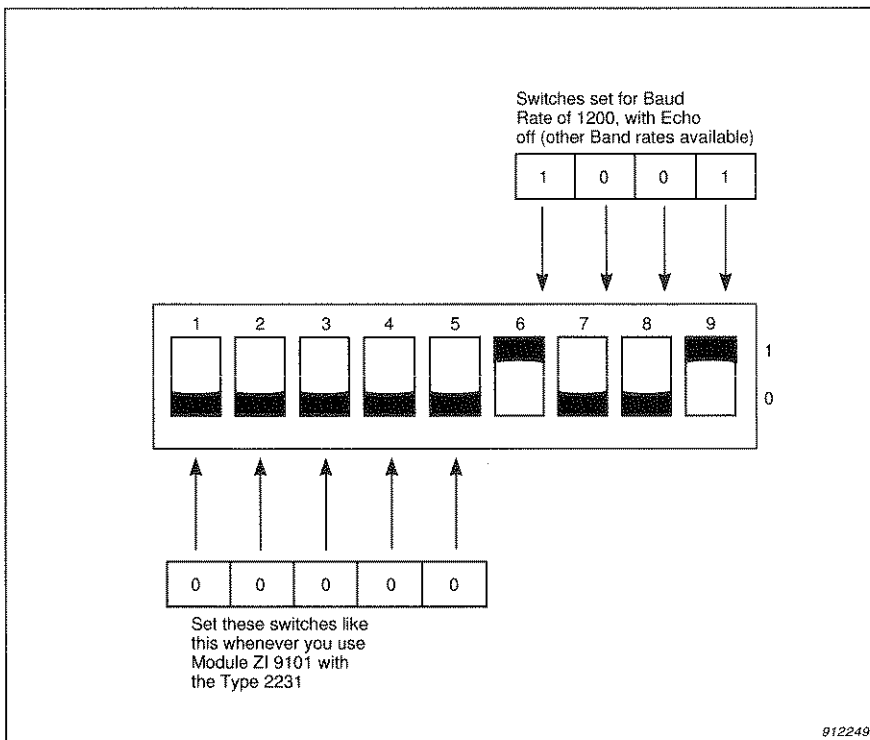

Fig. 5.3. Interface Module multi-switch settings for Type 2231, 1200 baud, echo off

5.2. Interface Module ZI9101

| | | SWITCH | | | | | | | | |
|-----------------------|-----------------|--------|---|---|---|---|--------|---|---|---|
| | | 1 | 2 | 3 | 4 | 5 | 6 | 7 | 8 | 9 |
| SLM Type/ Mode | 2230 Data-log | 0 | 0 | 1 | 1 | 1 | FORMAT | | | |
| | 2230 PC control | 0 | 1 | 1 | 1 | 1 | | | | |
| | 2230 Printer | 1 | 1 | 1 | 1 | 1 | | | | |
| | 2233 Printer | 1 | 0 | 1 | 1 | 1 | | | | |
| | 2231 | 0 | 0 | 0 | 0 | 0 | | | | |
| Baud Rate | 110 | | | | | | 0 | 0 | 0 | |
| | 150 | | | | | | 0 | 0 | 1 | |
| | 300 | | | | | | 0 | 1 | 0 | |
| | 600 | | | | | | 0 | 1 | 1 | |
| | 600 | | | | | | 0 | 1 | 1 | |
| | 1200 | | | | | | 1 | 0 | 0 | |
| | 2400 | | | | | | 1 | 0 | 1 | 1 |
| | 4800 | | | | | | 1 | 1 | 0 | 1 |
| | 9600 | | | | | | 1 | 1 | 1 | 1 |
| Echo | On | | | | | | | | | 0 |
| | Off | | | | | | | | | 1 |

T02021GB0

Table 5.1. Interface Module ZI9101 switch settings

Note: Baud is a rate of digital information transfer, equal to 1 bit per second). The higher the baud rate, the quicker will be communication between two digital devices.

5.2. Interface Module ZI 9101

5.2.3. Interface Specifications

The Brüel & Kjær Serial Interface (B & K-SI) is structured close to the EIA Standard RS-232 (equivalent to CCITT V 24) and, when fitted with the interface module, the sound level meter can communicate with almost any equipment whose interface conforms to these standards (see section 5.3). The main difference between B & K-SI and RS-232 is that the B & K interface uses lower signal voltages, thus reducing power consumption. See section 8.6 for more details on connecting the sound level meter to RS-232 equipment.

The following specifications apply to B & K-SI:

- 1 Start Bit
- 8 Data Bits
- 1 Stop Bit
- No Parity Bit

| | B & K - SI | RS-232-C |
|---|--|--|
| Connector | 5 Pin LEMO (ZI 9101) or 25 Pin "D"-Type (ZI 9101 with AO 0335) | Not specified. 25 Pin "D" - Type generally used |
| Signal Voltage Level (Open-circuit Load) | ± 5 V (Nominal) | ± 12 V (Nominal) |
| (Max. Load) | Min. at Sender ± 2 V Min. at Receiver ± 1 V | Min. at Sender ± 5 V Min. at Receiver ± 3 V |

T02022GB0

Table 5.2. B & K-SI and RS-232 comparisons

5.2. Interface Module ZI9101

| Mnemonic | Signal Name (B & K - SI) | Pin No. (ZI9101) | Pin No. (ZI9101 with AO 0335) |
|----------|-----------------------------|---------------------|----------------------------------|
| EXTC | Externals Connected | 1 | 5 + 6 + 8 |
| HS | Handshake | 2 | 20 |
| TD | Transmitted Data | 3 | 3 |
| SG | Signal Ground | 4 | 7 |
| RD | Received Data | 5 | 2 |
| PG | Protective Ground | Screen | 1 |

T02024GB0

Table 5.3. Pin connections

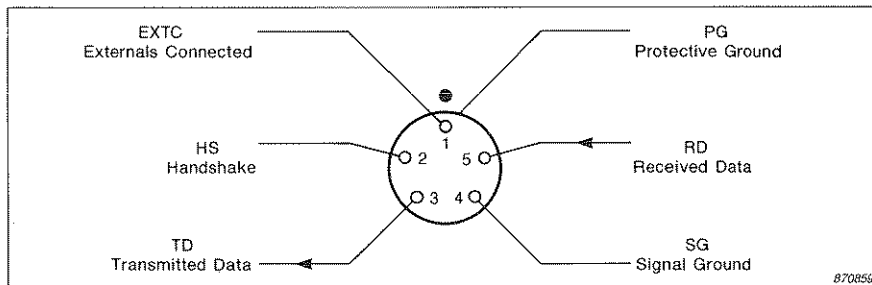

Fig. 5.4. Pin designations for the 5-pin plug on Interface Module ZI9101

5.3. Filter Sets

If you want to make measurements which take only specific frequency bands into account, use a filter set with the sound level meter. The following filter sets are compatible with the Type 2231.

- Octave Filter Set Type 1624
- Octave and $\frac{1}{3}$ Octave Filter Set Type 1625
- Infrasound and Ultrasound Filter Set Type 1627

For full details on the use of Filter Sets Type 1624, 1625, and 1627 for frequency analysis with the Sound Level Meter Type 2231, please read the Instruction Manuals for these Filter Sets. Fig 5.6 shows Filter Set Type 1625 attached to the sound level meter. The other filter sets are attached in the same way.

Filter Set Type 1624

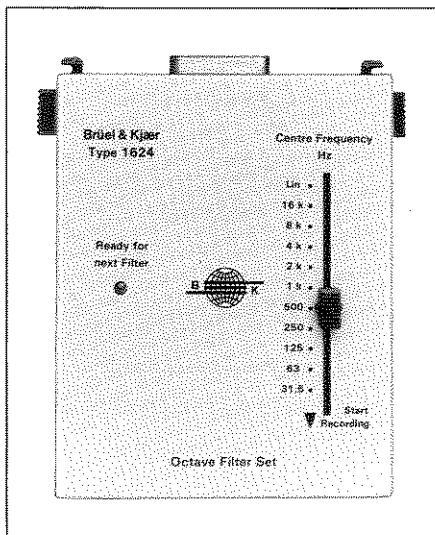

Filter Set Type 1624 has 10 octave band filters with centre frequencies from 31.5 Hz to 16 kHz, and a "Lin." position. Graphs can be plotted with Level Recorder Type 2317 (see section 5.4).

Fig. 5.5. Filter Set Type 1624

5.3. Filter Sets

Filter Set Type 1625

Filter Set Type 1625 allows $\frac{1}{3}$ -octave band analysis (in $\frac{1}{3}$ -octave steps) or octave band analysis (in octave or $\frac{1}{3}$ -octave steps). The centre frequencies for the octave and $\frac{1}{3}$ -octave filters are from 20 Hz to 20 kHz. The Type 1625 has 31 overlapping octave filters, 31 active $\frac{1}{3}$ octave filters and a "Lin." filter. Graphs can be recorded and plotted using Level Recorder Type 2317. The recording is fully automatic, and produces an accurate recording in as short a time as possible. The display of the filter shows the centre frequency currently being used.

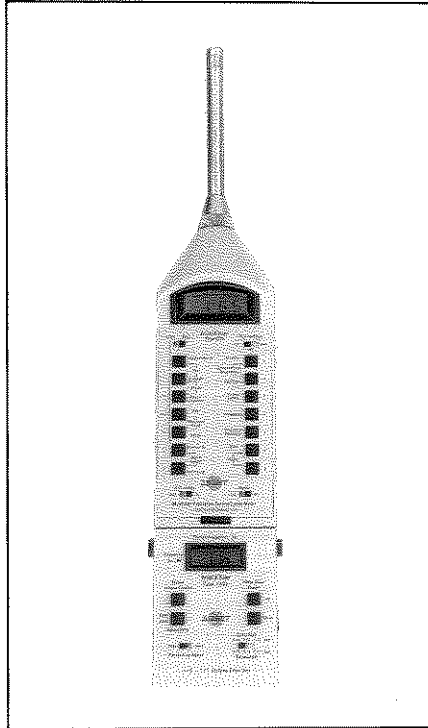

Fig. 5.6. Filter Set Type 1625 attached to the sound level meter. Filter Sets 1624 and 1627 are attached in the same way

5.3. Filter Sets

Filter Set Type 1627

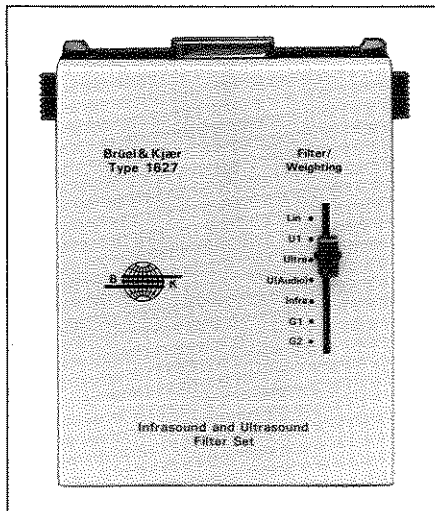

Fig. 5.7. Filter Set Type 1627

Filter Set Type 1627 has 6 filter networks, together with a Lin. filter. The filter characteristics are as follows:

- U1:** 16 kHz Ultrasound weighting
- Ultra:** 12.5 kHz Highpass Filter
- Audio:** 10 Hz to 12.5 kHz Band-pass including U-Weighting in accordance with IEC TC 29-169/WG16.
- Infra:** 20 Hz Lowpass Filter
- G1, G2:** 20 Hz Infrasound Weighting in accordance with ISO/DIS 7196.

This filter set can make measurements in the infrasound and ultrasound ranges. It also uses the extended frequency range characteristics of the Sound Level Meter Type 2231. The 2231 has an electrical frequency range of 1 Hz to 70 kHz. With Microphones Type 4155 and 4165, use Adaptor UC 5265 (supplied with Filter Set Type 1627) for low frequency applications.

5.4. Level Recorder Type 2317

Level Recorder Type 2317 provides quick, accurate graphic plots of measured signals sent to it from the AC and DC outputs of the sound level meter.

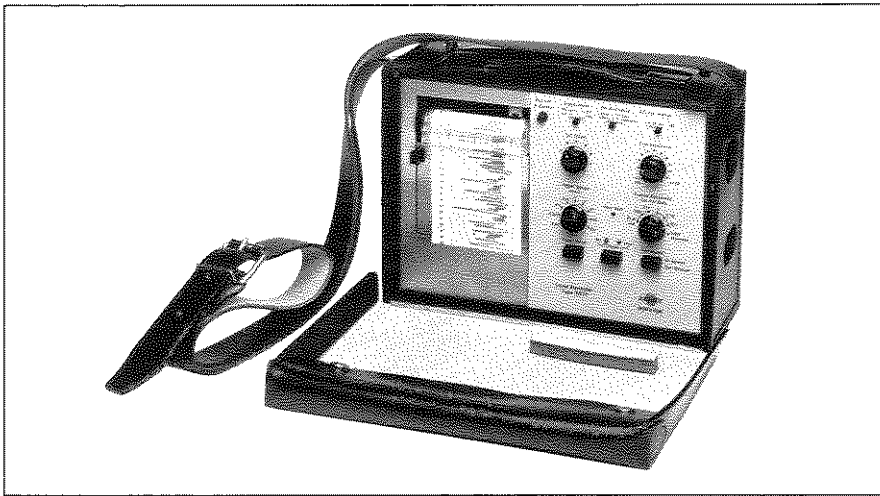

Fig. 5.8. Level Recorder Type 2317

Figs. 5.9 to 5.11 give examples of recordings made with the Type 2231 and Type 2317. Fig. 3.13 in section 3.15.7 shows a plot of L_{eq} vs. time obtained with Level Recorder Type 2317. For instructions on how to use the Type 2231 and Type 2317, see the instruction manual for the Type 2317.

5.4. Level Recorder Type 2317

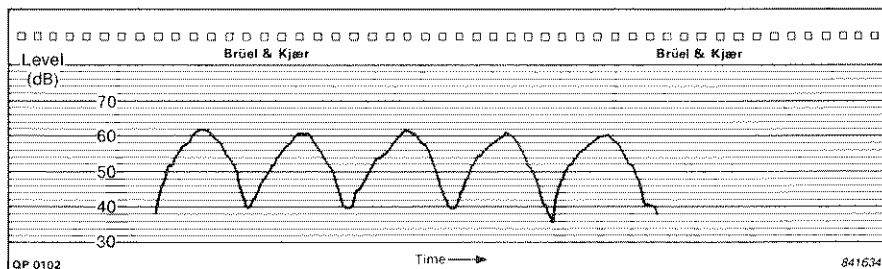

Fig. 5.9. Sound signal recording using the AC output of the 2231 Sound Level Meter. The AC Averaging switch on the 2317 Level Recorder is set to "Fast", and the Paper Speed is set to 3 mm/s

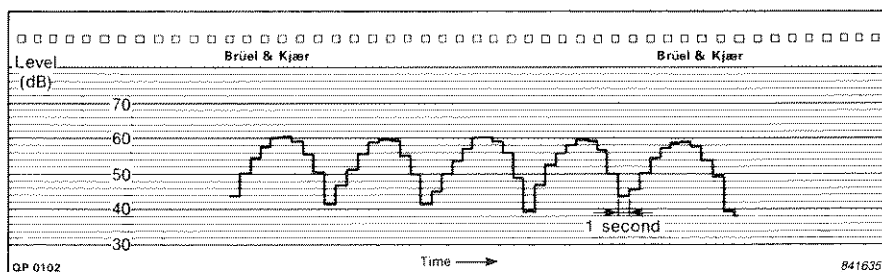

Fig. 5.10. Recording of the same sound signal using the DC output of the 2231 Sound Level Meter. The Time Weighting of the 2231 is set to "Fast" and the Displayed Parameter is set to "SPL". Note how the recorded signal is stepped in appearance. This happens because the DC output of the 2231 is updated only once per second. Each step represents the highest sound pressure level measured in the previous second

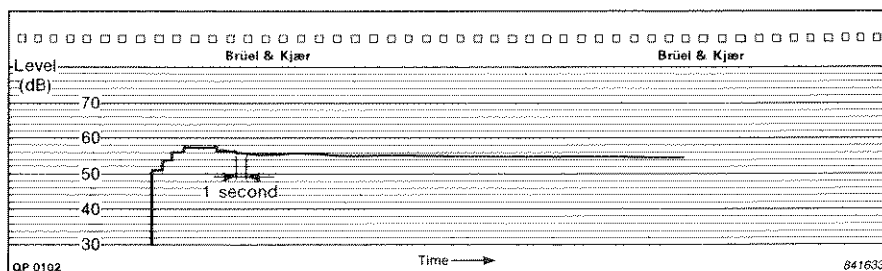

Fig. 5.11. Recording of the same sound signal using the DC output of the 2231 Sound Level Meter. The Time Weighting of the 2231 is set to "Fast" and the Displayed Parameter is set to "LEQ". The fluctuations of the recorded signal are minimal because of the integration of the sound signal over the measurement period

6.1. Hints for Trouble-free Use

- When connecting the sound level meter equipment to another device, switch the equipment **off**. If you do not do this, the equipment could get damaged.
- Handle the microphone carefully, and try to keep dust and foreign objects off its diaphragm.
- Never touch the microphone diaphragm: if you have to clean it, use (very lightly) a soft brush or cotton wool swab.
- Never attach the microphone with the sound level meter power on.
- Be very gentle when attaching a microphone, extension cable, input stage etc.
- Do not expose the sound level meter and accessories to excessive damp, cold or heat.
- Make sure the batteries are in good condition. Leaking batteries can damage the sound level meter.
- Keep the sound level meter stored in a dry place, preferably in the special carrying case (Brüel & Kjær order No. KE 0226).
- When storing the sound level meter for a long time, remove the batteries.

6.2. Service and Repair

The Type 2231 is a strong, resilient instrument which, with proper care and attention as outlined in section 6.1, will provide you with many years of reliable operation. However, if at any time you suspect that the instrument is not working correctly, remove the batteries to prevent risk of further damage. For repair, contact your local Brüel & Kjær service representative. Under no circumstances should repair be attempted by persons not specially trained in the service of Brüel & Kjær equipment.

7.1. Specifications: Sound Level Meter Type 2231

STANDARDS FULFILLED:

With Microphone Type 4155:

IEC 804 Type 1 and relevant sections of IEC 651 Type 1 I

ANSI S1.4 - 1983 Type 1

With Microphone Type 4133 and Extension Cable AO0027:

IEC 804 Type 0 and relevant sections of IEC 651 Type 0 I (references to Type 0 in these Specifications assume use of Type 4133 and AO0027)

MEASURING RANGES:

With supplied microphone (Type 4155):

| FSD ¹ | Measuring Range | | |
|------------------|---|------------------------------|--|
| | Lower limit for S/N ratio > 5 dB (A-weighting) ³ | Max. peak level ³ | Upper limit for signals of crest factor, = 10 (20 dB) ³ |
| 60 | 24 | 73 | 53 |
| 70 | 24 | 83 | 63 |
| 80 | 24 | 93 | 73 |
| 90 | 30 | 103 | 83 |
| 100 | 40 | 113 | 93 |
| 110 | 50 | 123 | 103 |
| 120 | 60 | 133 | 113 |
| 130 ² | 70 | 143 | 123 |
| 140 ² | 80 | 153 | 133 |

¹ FSD on quasi-analogue display

² Only with attenuator ZF 0020 employed

³ Values may diverge slightly from nominal value depending on microphone K₀ factor

T02589GB0

FREQUENCY WEIGHTING:

"A" and "C" weightings in accordance with IEC 651 Type 0

Linear (10 Hz to 20 kHz)

All-pass (2 Hz to 70 kHz)

DETECTOR:

Characteristics: RMS and Peak in parallel

Linearity range: 70 dB

Pulse range: 73 dB

Crest factor capability: 13 dB at FSD

TIME WEIGHTING CHARACTERISTICS:

"T" "F" and "S" in accordance with IEC 651 Type 1 (Type 0)

"Peak": rise time < 50 μs

Max. Hold decay rate: 0 dB/s (digital)

SOUND INCIDENCE CORRECTION:

Frontal: Reference direction is perpendicular to microphone diaphragm. Microphone corrected for frontal incidence in a free sound field.

Random: Microphone corrected for sound incidence from random directions. The correction is also valid for diffuse fields.

RESPONSE TIME FOR CONSTANT INPUT SIGNAL:

1 s after reset

WARM-UP TIME: < 5 s

CONVERTIBILITY:

Loading: Enabled by module insertion: module removed after loading into internal memory. Every application module has its own front plate.

Capacity: 8 kbyte ROM for general routines, tables etc. 64 kbyte RAM for system, application software and data storage.

Battery back-up of RAM.

Interface: Via Interface Module ZI9101.

Open circuit signal level: ± 5 V

Min. send level: ± 2 V

Min. receive level: ± 1 V

DISPLAY:

Normal (Digital): 4 digits of 14 segments, liquid crystal, 8 mm high, resolution 0.1 dB

Differential (Quasi-analogue): 60 dB scale with 2 dB resolution for monitoring current SPL (RMS)

Additional functions:

Overload occurring: †

Overload has occurred: ^

Battery near low level: BAT flashing

Battery low: BAT flashing plus † (non-resettable)

Errors in loading module software

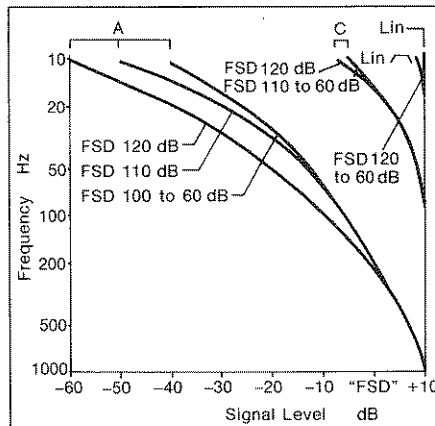

Lowest frequency for which the error resulting from non-linear distortion generated between the sound input and the signal output is less than ±1 dB (and no overload is indicated). The lowest frequency is given as a function of the measured signal level.

851128

7.1. Specifications: Sound Level Meter Type 2231

REAL TIME CLOCK:

Displays year, date and time. Powered by back-up battery when the sound level meter is switched off. Set by the Type 2231 pushkeys or over the digital interface

AC OUTPUT:

Short circuit protected; mini-jack socket
Full scale: 1 V RMS
Full range: 3.16 V RMS
Output impedance: $< 120 \Omega$

DC OUTPUT:

Short circuit protected; mini-jack socket
Full scale: 3 V
Full range: 3.5 V
Bottom scale: 0 V (50 mV/dB)
Overload condition: 5 V
Output impedance: $< 100 \Omega$

RESET FUNCTION:

Reset All: Max./min. detectors, L_{eq} , SEL and overload detector are reset
Automatic reset occurs when certain key settings are changed

MICROPHONE:

Type: 1/2-inch Brüel & Kjær Prepolarized Condenser Microphone Type 4155
Nominal Sensitivity: 50 mV/Pa (-26 dB re 1 V/pa)
Capacitance: 15 pF
Windscreen effect: < 0.9 dB up to 10 kHz
Polarization voltage: Selectable: 0 V, 28 V, 200 V. Allows use of almost any microphone in the Brüel & Kjær range.
K-Factor: Selectable: -60 dB to +99 dB. The K-Factor is the ratio (expressed in dB) of the actual microphone sensitivity to a reference sensitivity of -26 dB re 1 V/Pa.

CALIBRATION:

By potentiometer adjustment
Acoustical: With Sound Level Calibrator Type 4230, Pistonphone Type 4228 or Multifunction Acoustic Calibrator Type 4226
Electrical: With internal reference source

REFERENCE CONDITIONS FOR

ACOUSTICAL CALIBRATION

(AS OBTAINED WITH type 4230):

Type of Sound Field: Free
Reference Incidence Direction: Frontal (perpendicular to microphone diaphragm)
Reference SPL: 94 dB (re 20 μ Pa)
Reference Frequency: 1 kHz
Reference Temperature: +20°C (+68°F)
Reference Measuring Range: 110 dB FSD

EFFECT OF HUMIDITY (AT 40°C AND 1000Hz):

< 0.5 dB for 30% < RH < 90%

EFFECT OF TEMPERATURE:

Microphone: -0.006 dB/°C typically
Complete instrument:
 < 0.5 dB (-10 to +50°C (+14°F to +122°F))
Operating range:
-10 to +50°C (+14 to 122°F)
Storage without batteries:
-20 to +70°C (-4 to 158°F)

VIBRATION SENSITIVITY: 72 dB max. at 40 Hz and 1 m/s²

EFFECT OF MAGNETIC FIELD:

80 A/m (1 Ørsted) at 50 Hz gives:
 < 25 dB (A) or < 44 dB (Lin)

ELECTROMAGNETIC COMPATIBILITY:

Complies with Class B computing device of the American FCC (Federal Communications Commission) Rules.

POWER:

Batteries: Four 1.5 V, LR6 or AA size alkaline batteries (order no. QB0013)
Life: Approx. 8 hours
Mains supply: Mains Power Supply and Charger ZG0254; includes a battery box with 4 rechargeable Ni-Cd batteries

OVERALL DIMENSIONS AND WEIGHT:

370 × 85 × 47 mm (14.7 × 3.3 × 1.8 in)
1 kg (2.2 lb) with batteries

7.2. Specifications: Application Module BZ 7110

MEASUREMENT DATA:

The following data can be viewed without disrupting a measurement. All the data is updated during measurements:

- SPL
- L_{eq} (L_{im})
- SEL (IEL)
- UNR*
- OVR*
- OVL*
- MinL
- MaxL
- MaxP
- Inst.
- Peak
- K-Factor
- Preset Time
- Real Time Clock
- Elapsed Time
- Time Weighting
- Frontal/Random
- Frequency Weighting
- Measuring Range (FSD)
- Displayed Parameter

The following data can be output to a printer or computer:

- All data given above
- Record No.
- Date
- Error Indicator
- Pause Counter
- Reset Max./Min. Counter

* Given as % of measurement time.

7.3. Ordering Information

Type 2231: Modular Precision Sound Level Meter

Includes the following accessories:

Integrating SLM Module BZ 7110
Front Plate
Prepolarized Condenser Microphone Type 4155
20 dB Attenuator ZF 0020
Windscreen UA 0237
Input Adaptor JJ 2614
2.5 mm Mini-Jack Plugs (2×) JP 0213
Screwdriver QA 0001
Alkaline Batteries (4×) QB 0013

OPTIONAL ACCESSORIES:

For Calibrating:

Sound Level Calibrator Type 4230
Pistonphone Type 4228

For Transferring Data:

Interface Module ZI 9101

For Printing Results:

Graphics Printer Type 2318
Interface Module ZI 9101

For Using with a Computer:

Terminal Software BK-LINK

For Frequency Analysis:

Octave Filter Set Type 1624
 $\frac{1}{3}$ - $\frac{1}{4}$ Octave Filter Set Type 1625
Infrasound and Ultrasound Filter Set . Type 1627

For Level Recording:

Level Recorder Type 2317
Level Recorder Cable AO 0173

Other Accessories:

Carrying Case KE 0226
Portable Tripod UA 0801
Mains Power Supply and Charger ZG 0254
3m Microphone Extension Cable AO 0027

Other Application Modules:

"Taktmaximal" BZ 7102
Frequency Analysis BZ 7103
Event Recording BZ 7107
Reverberation Time BZ 7108
Room Acoustics BZ 7109
Loudness BZ 7111
Short-term L_{eq} BZ 7112
Calculation of Loudness BZ 7113
Building-acoustics BZ 7114
Statistical Analysis BZ 7115
Human-vibration BZ 7116

Contact your local Brüel & Kjær representative for details of all the current Type 2231 Application Modules.

8.1. Choice of Microphone

Modular Precision Sound Level Meter Type 2231 can accommodate almost any microphone in the Brüel & Kjær range, since the polarization voltage it supplies is selectable between 0 V, 28 V, and 200 V. The standard microphone supplied with the sound level meter, Prepolarized Microphone Type 4155, is probably suitable for almost every application that the sound level meter will be used for. Unless you intend to use the instrument for the following applications, do not change the microphone:

High-frequency, high-level sound measurements and model work.

¼-inch Microphones Type 4135 and 4136 are ideal.

Very high-frequency, high-level sound measurements, pulse measurements and model work.

⅛-inch Microphone Type 4138 is ideal. Being so small, Type 4138 is especially suitable for situations which require a high degree of spatial resolution or where space is limited.

Type 0 Sound Level Meter.

½-inch Microphone Type 4133, together with Extension Cable AO 0027 enables the sound level meter to fulfil IEC 804 Type 0 and relevant sections of IEC 651 Type 0. This is possible because the frequency characteristics of the 4133 are flatter than those of the 4155, and the use of the extension cable eliminates the reflection effects of the sound level meter body on the immediate sound field.

8.1. Choice of Microphone

Artificial Ear measurements.

Artificial Ears Type 4152 and 4153 use 1-inch Microphone Type 4144 and ½-inch Microphone Type 4134 respectively. These microphones both require 200 V polarization voltage and must be used since their dimensions and acoustic impedances are an integral part of the correct functioning of the Artificial Ears.

Measurements inside confined spaces.

Probe Microphone Type 4182 can be used for measurements inside the ear and inside hearing protectors, measurements on sound insulating materials, and measurements inside intricate machinery and small ducts. It can also be used for short-term measurements at several hundred degrees centigrade such as in oil burners, furnaces etc.

Of course it is not absolutely necessary to use the standard supplied microphone with the sound level meter. However, before using any other microphone type, consult the Brüel & Kjær Data Sheet "Condenser Microphone Cartridges", or the Brüel & Kjær Data Handbook "Condenser Microphones" to ensure that the microphone is suitable for your application. Please note the following restrictions:

Type 4147 cannot be used with the 2231 to measure sound down to frequencies of 0.01 Hz, because the 2231 cannot provide the 10 MHz carrier signal which must be modulated in order to detect such low frequency sound.

Type 4184 is a weatherproof microphone unit, ideal for use in situations where a permanent outdoor set-up is required. The Type 4184 is used in connection with Power Supply WB1196.

8.1. Choice of Microphone

The **directivity** of the sound level meter (see section 8.3) is given only for the standard microphone (Type 4155) with Input Stage ZC0020. Use of another microphone size will change these directivity characteristics.

The **Frontal/Random** setting on the sound level meter (see section 8.2) must be set at "**Frontal**" for any microphone that is not a 1/2-inch free-field corrected microphone. The "**Random**" setting is valid only for 1/2-inch free-field corrected microphones such as the Type 4155.

8.2. Type of Sound Field

Linear Free-field or Diffuse Field?

Microphone Type 4155, the standard microphone for the Type 2231, has a linear free-field response for 0° sound incidence. Under diffuse-field conditions, you can obtain a linear response by correcting the microphone output. To do this, use the **Frontal/Random** pushkey (see section 3.6) which lets you select the proper sound incidence correction parameter. Fig. 8.1 helps you decide whether to use the **"Frontal"** or **"Random"** setting.

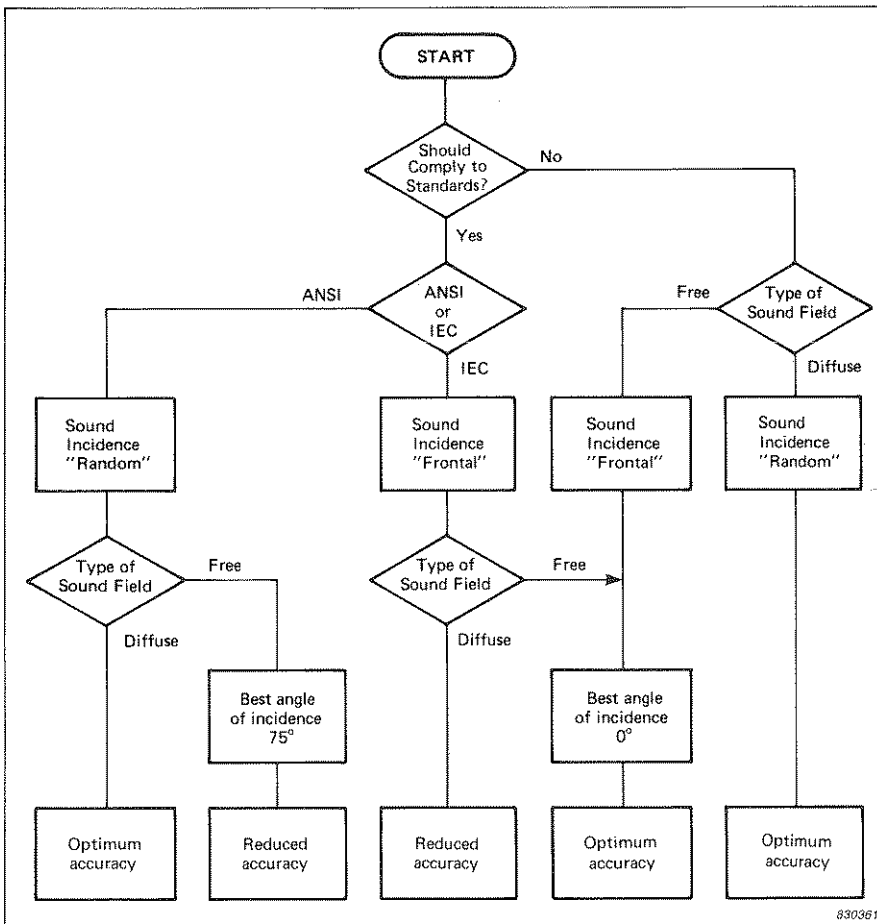

Fig. 8.1. Flow chart to help you choose either the Frontal or Random setting

8.2. Type of Sound Field

IEC Standard:

- Select **“Frontal”** sound incidence correction.
- For free-field conditions, point the sound level meter straight at the source, as shown in Fig. 8.2).

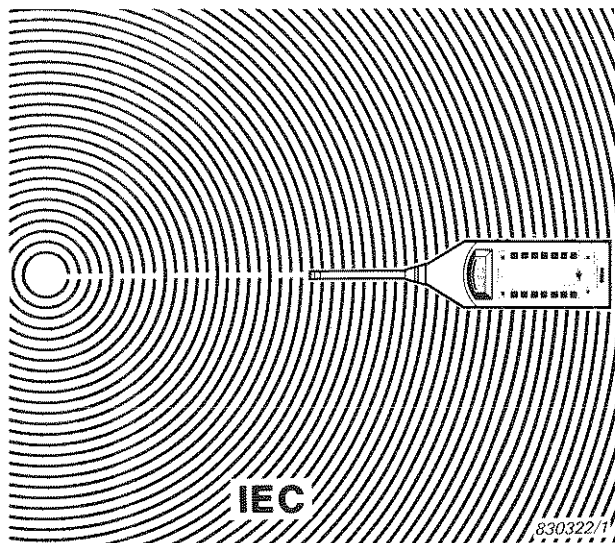

Fig. 8.2. Free-field measurements according to IEC recommendations

8.2. Type of Sound Field

ANSI Standard:

- Select **“Random”** sound incidence correction.
- For diffuse-field conditions, point the sound level meter in any direction.
- Under ideal free-field conditions, you can obtain the best results by pointing the sound level meter as shown in Fig. 8.3.

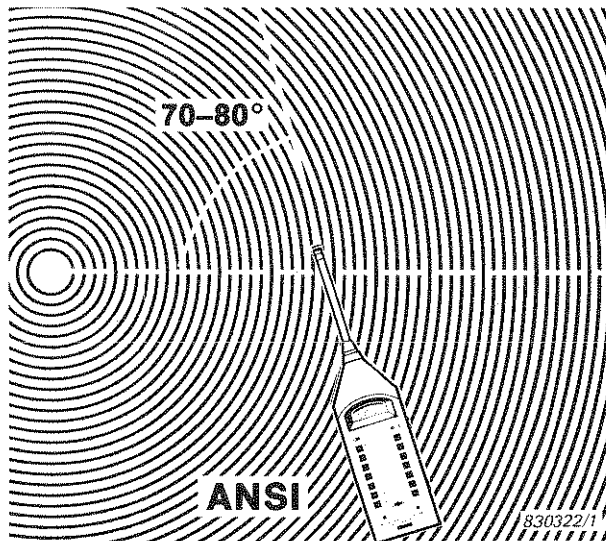

Fig. 8.3. Free-field measurements according to ANSI recommendations

8.2. Type of Sound Field

Measurements Not Requiring Strictly IEC or ANSI Standard Characteristics (or Those of Equivalent National Standards):

- Select “**Frontal**” sound incidence correction under free-field conditions or when you can locate the source.
- Select “**Random**” sound incidence correction under diffuse-field conditions or when the Sound Level Meter is moved around during L_{eq} measurements.

Note:

- For each setting of **Frontal/Random**, there will be certain conditions under which one setting will be less accurate than the other. To be as accurate as possible, follow the guidelines given in Fig. 8.1.
- The **Frontal/Random** correction networks are valid only for 1/2-inch free-field corrected microphones. Select “**Frontal**” when using other types of microphone with the sound level meter.

8.3. Instrument Characteristics

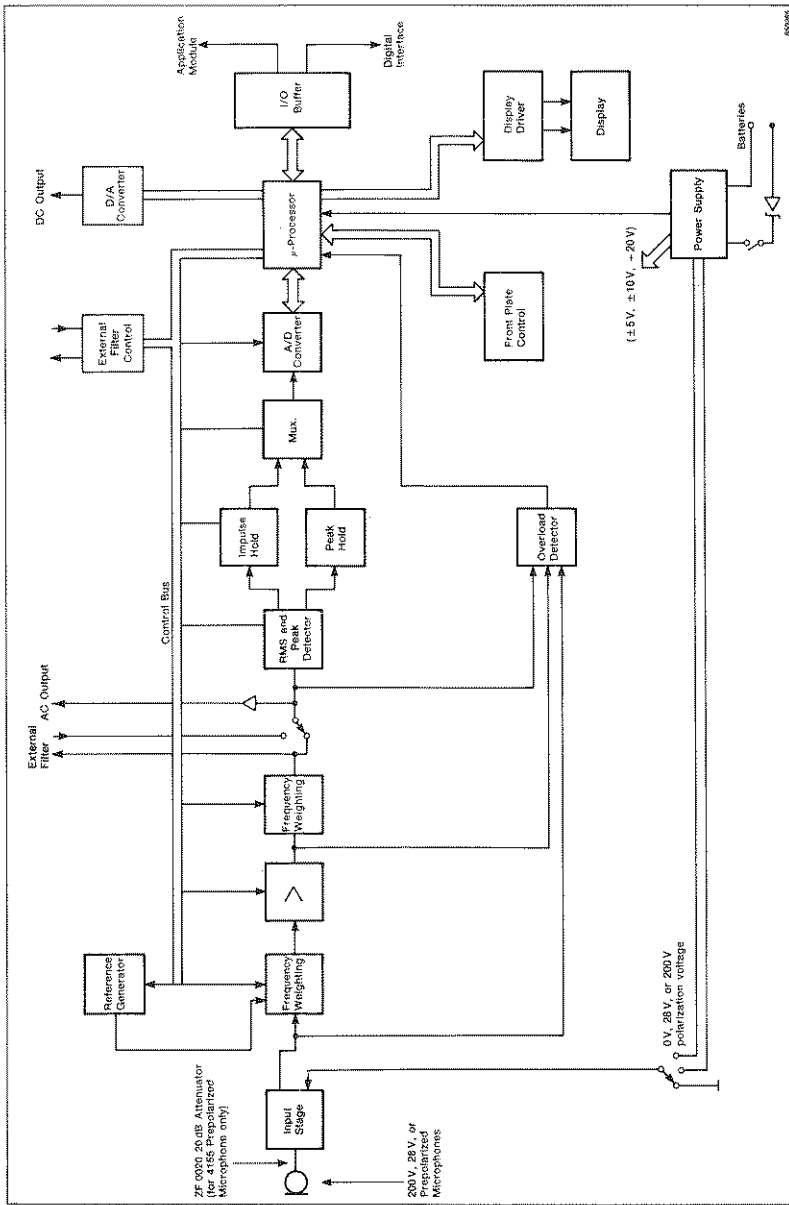

Fig. 8.4. Type 2231 block diagram

8.3. Instrument Characteristics

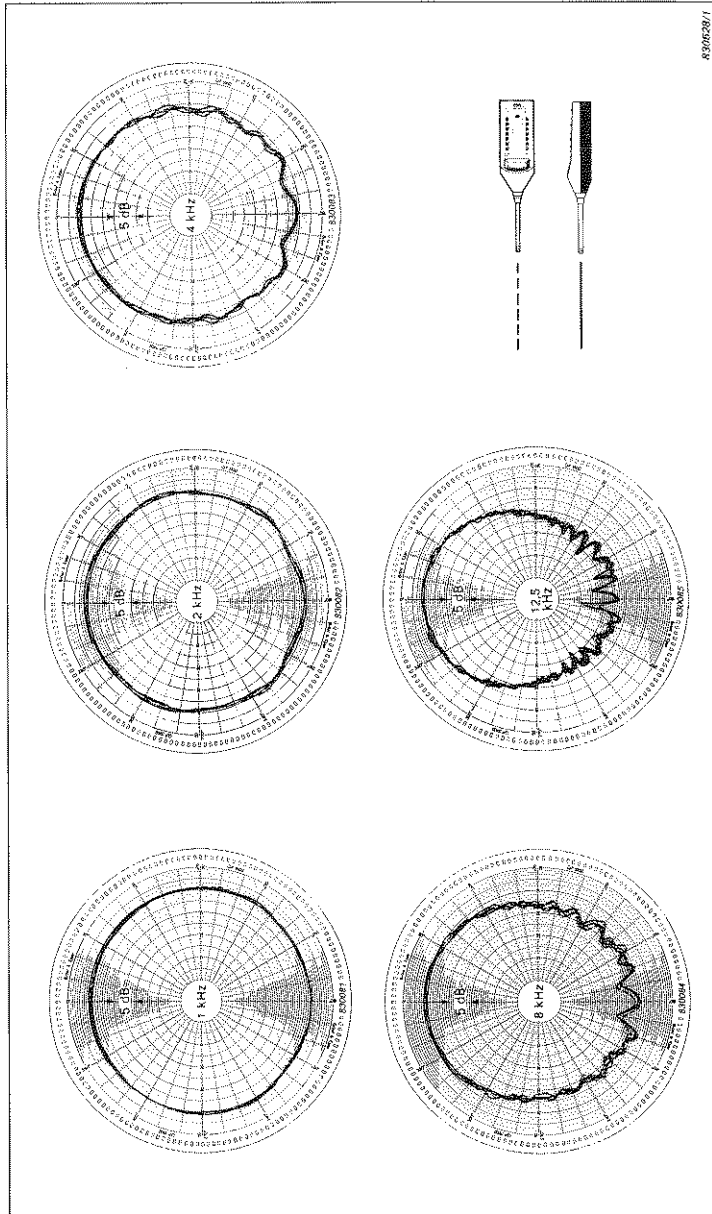

Fig. 8.5. Directional characteristics of the complete instrument at 0.8 / 1.2 kHz; 1.8 / 2.1 kHz; 3.85 / 4.1 kHz; 7.8 / 8.2 kHz and at 12.5 / 13.0 kHz

8.3. Instrument Characteristics

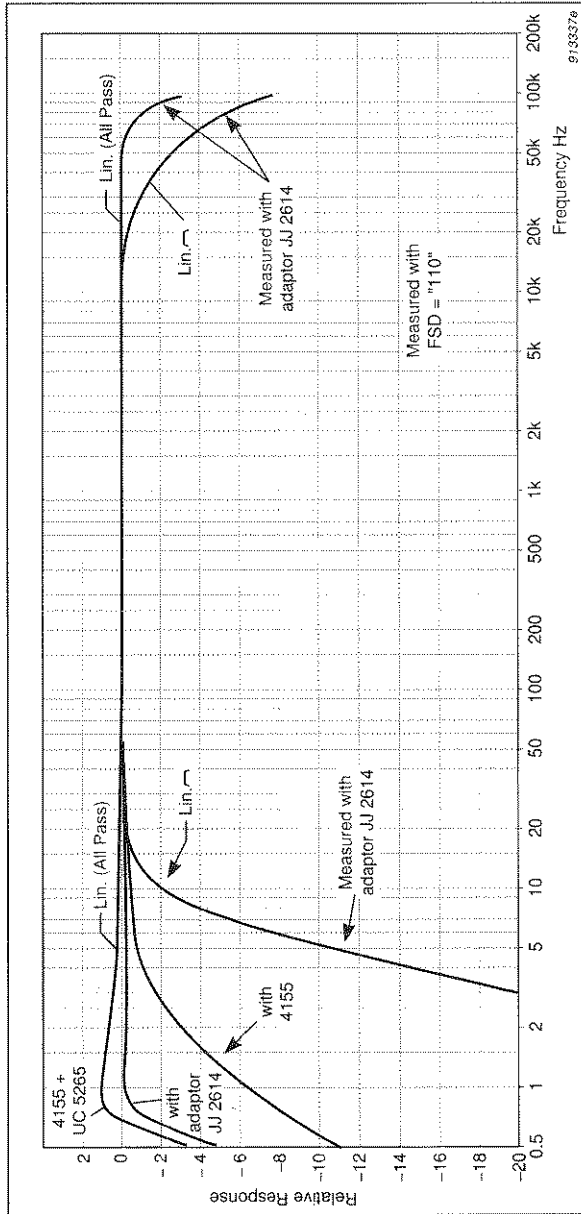

Fig. 8.6. *Lin. (10 Hz to 20 kHz) and All-pass (2 Hz to 70 kHz) frequency characteristics*

8.3. Instrument Characteristics

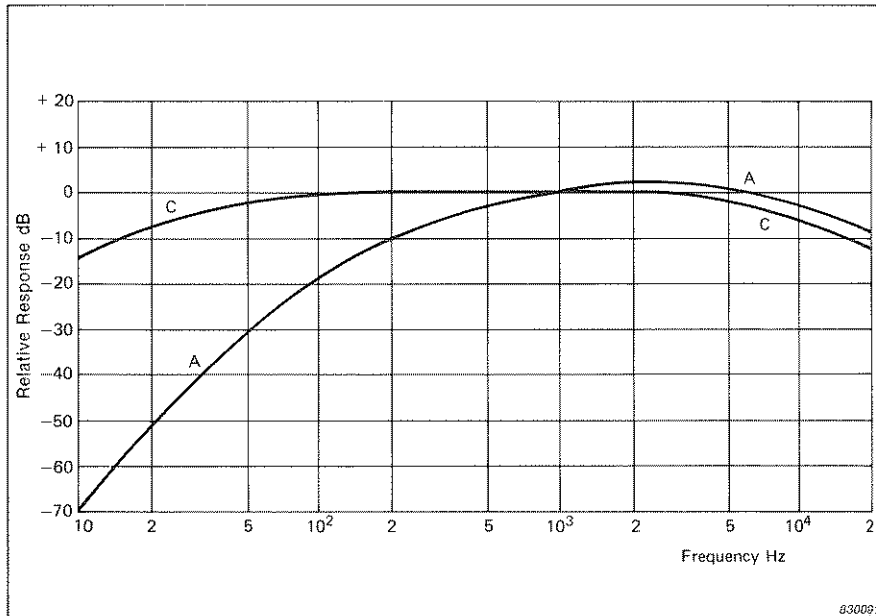

Fig. 8.7. Nominal "A" and "C" weighting frequency characteristics

8.3. Instrument Characteristics

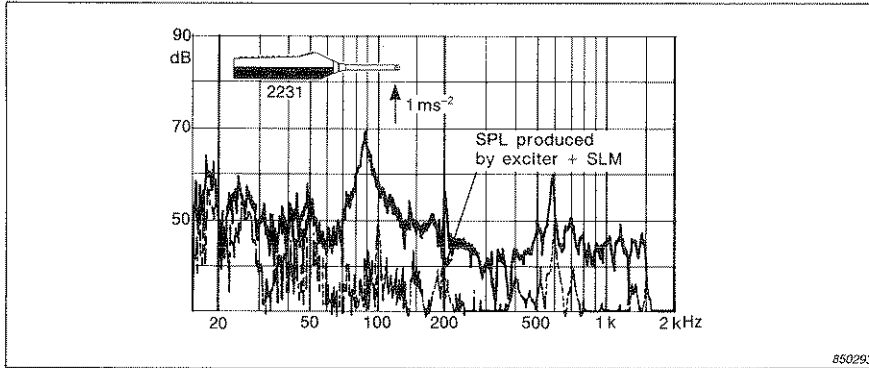

Fig. 8.8. Equivalent sound pressure level when the complete sound level meter (back facing down) is excited horizontally at 1 ms⁻²

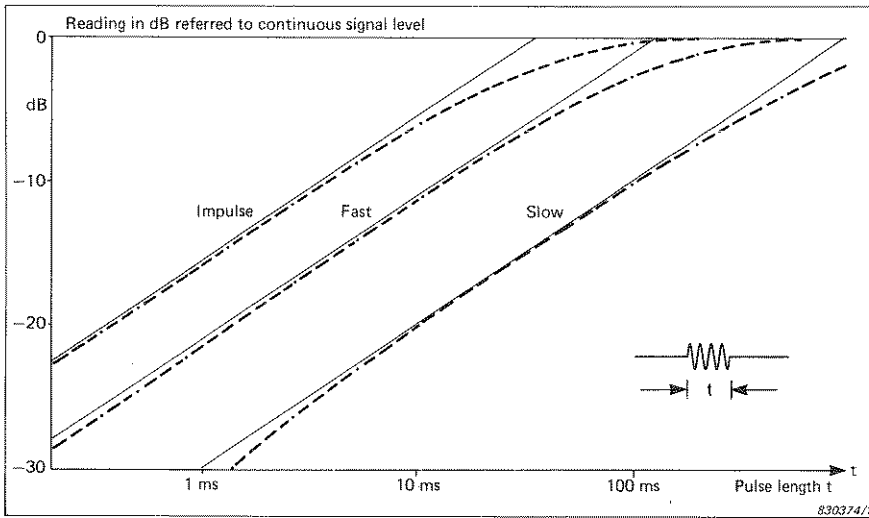

Fig. 8.9. Response of the sound level meter rectifier to tone bursts of varying characteristics

8.3. Instrument Characteristics

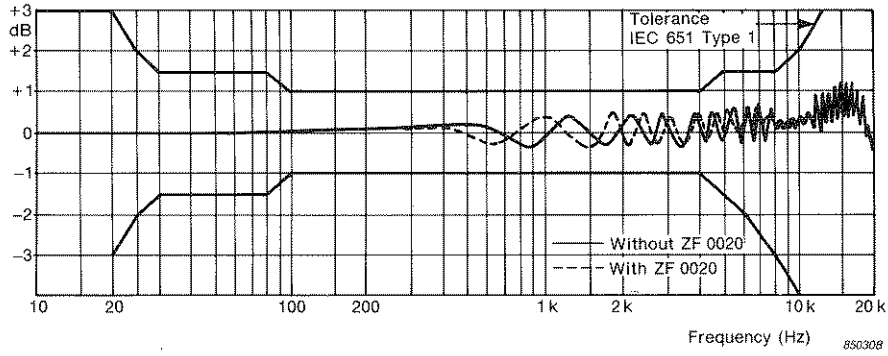

Fig. 8.10. Typical 0° free field frequency response of the complete instrument

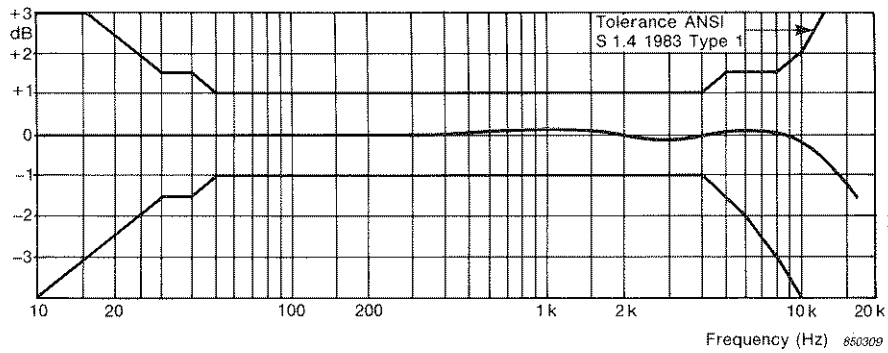

Fig. 8.11. Typical diffuse field frequency response of the complete instrument

8.3. Instrument Characteristics

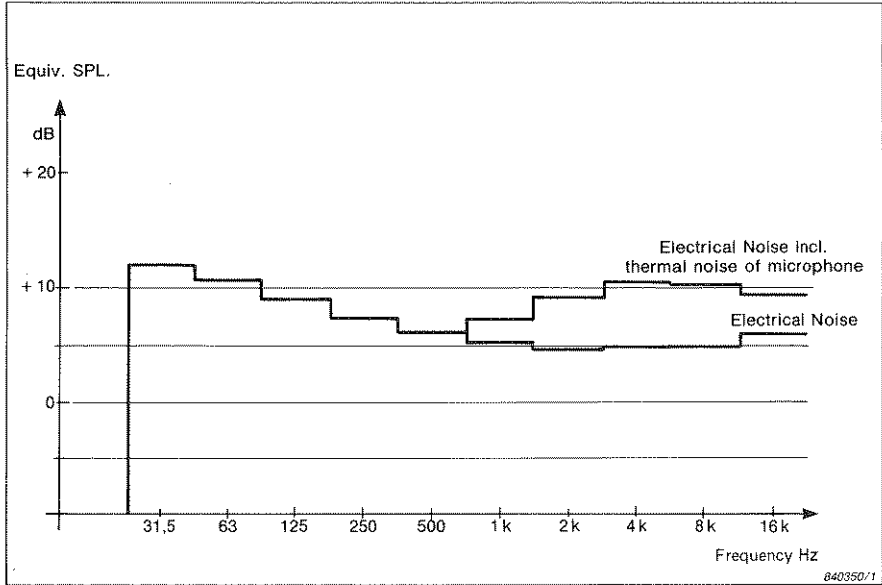

Fig. 8.12. 2231 noise floor in octave bands

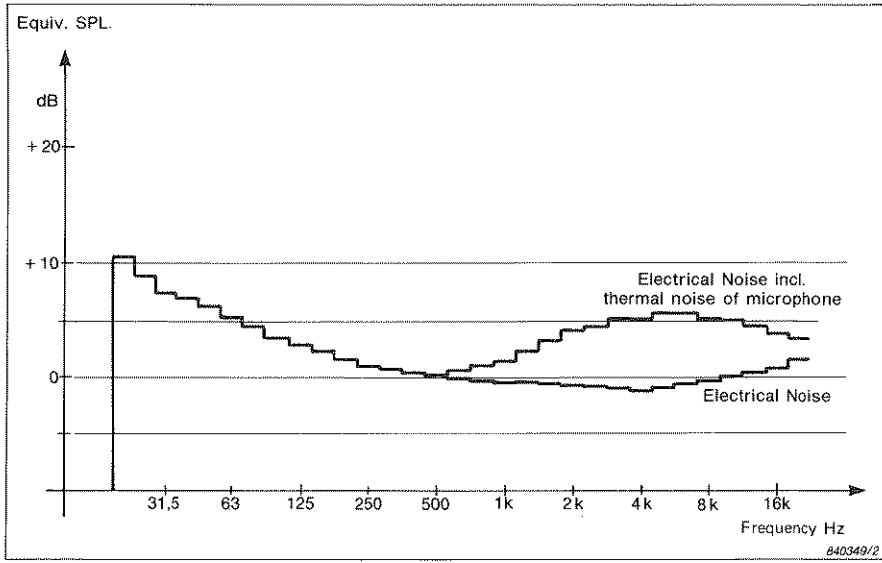

Fig. 8.13. 2231 noise floor in 1/3-octave bands

8.3. Instrument Characteristics

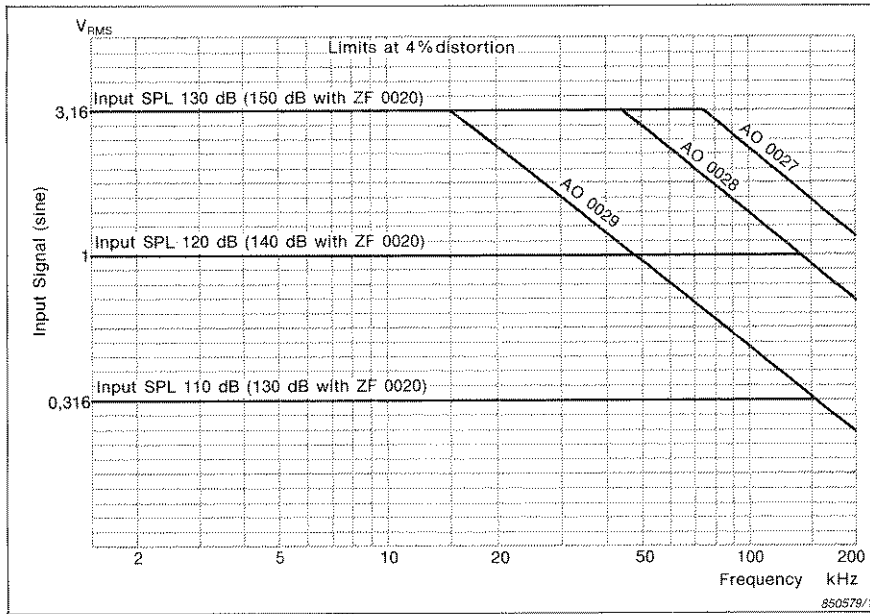

Fig 8.14. Attenuation of the measured signal due to different extension cables

8.4. Description of L_{eq} and SEL

L_{eq} :

L_{eq} is the continuous steady state sound pressure level which would have the same total acoustic energy as the real fluctuating noise over the same time period. According to IEC 804, the A-weighted L_{eq} should be denoted L_{Aeq} . The measurement of L_{eq} is based on the equal energy principle:

$$L_{eq,T} = 10 \text{ Log}_{10} \frac{1}{T} \int_0^T \left(\frac{p(t)}{p_0} \right)^2 dt \quad \text{dB}$$

where,

$p(t)$ = the time varying sound pressure

p_0 = the reference sound pressure ($20 \mu\text{Pa}$)

T = the time interval over which the sound pressure is measured

SEL (L_{EA}):

Sound Exposure Level SEL (i.e. L_{EA} in accordance with IEC 804) is the constant level which if maintained for a period of 1 second would have the same acoustic energy as the measured noise event, and is defined as:

$$\text{SEL} = L_{EA} = 10 \text{ Log}_{10} \frac{1}{T_0} \int_0^T \left(\frac{p(t)}{p_0} \right)^2 dt \quad \text{dB}$$

where,

$T_0 = 1 \text{ s}$

SEL (L_{EA}) is related to L_{Aeq} by the following relationship:

$$\text{SEL} = L_{EA,T} = L_{Aeq,T} + 10 \log_{10} (T/T_0) \quad \text{dB}$$

8.5. Connection to RS-232 Equipment

The RS-232 standard was developed for connecting terminals (Data Terminal Equipment: DTE) to modems (Data Communications Equipment: DCE). Any equipment having a RS-232 interface must conform to the standard for either DTE or DCE.

It is possible to connect two devices directly only if one conforms to the standard for DCE and the other to that for DTE, as shown in Fig. 8.15.

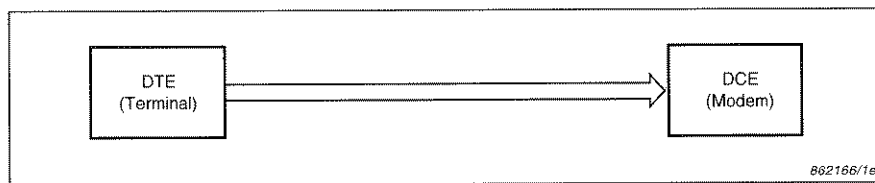

Fig. 8.15. DTE (terminal) - DCE

Modular Precision Sound Level Meter Type 2231 functions as a DCE device and, when fitted with Interface Module ZI9101, can be connected directly to DTE devices such as terminal or microcomputers. For connection to other DCE devices, some pin connections must be interchanged. This is done by using either a custom-built cable or a cross-connection unit, as shown in Fig. 8.16.

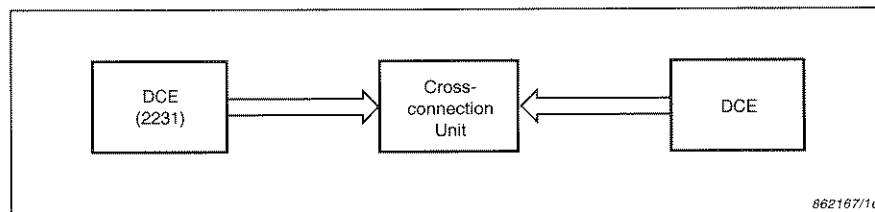

Fig. 8.16. DCE (2231) - Cross-Connection - DCE

8.5. Connection to RS-232 Equipment

The connections of the cross-connection unit should be as shown in Fig. 8.17.

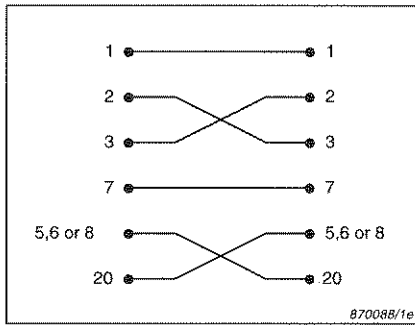

Fig. 8.17. Connections in a cross-connection unit

Table 5.3 in section 5.2.3 gives details of the pin connections for Interface Module ZI9101.

Pushkey Directory

(L) or (R) = **Load/Run** switch set to “**Load**” or “**Run**” for particular pushkey command.

Load/Run: Load – program accepts initialization commands. Run – program is executed.

Module No. 11: (L) – Load module software. (R) – Display status of loaded software.

Test: Activates Display test.

K-Factor: (L) – Enter microphone K-factor. (R) – Display K-factor.

Exit Recall: (R) – Return meter to normal operation from the Recall to Display mode.

Special Function: (L) – Enter special function code to modify standard program. (R) – Display status of special functions.

s: (L) – Enter “seconds” of Preset Time. (R) – Displays “seconds” of Preset or Elapsed Time.

Preset Time: (L) – Set measurement time (up to 100 hours). (R) – Display preset time.

+/-: (L) – Select sign of K-factor.

Real Time Clock: Current time.

Elapsed Time: (R) – Time elapsed since start of measurement.

0: (L) – Zero.

Selector ▲: (R) – Select next parameter “up” in Time Weighting, Frequency Weighting, Frontal/Random, FSD, and Displayed Parameter functions.

Selector ▼: (R) – Ditto, except select the next parameter “down”.

1: (L) – One.

2: (L) – Two.

Digital Output: Start output of results via interface module.

Ext. Filter Out/In: Enable attached filter.

Pol. Voltage: Select Polarization Voltage (0 V, 28 V or 200 V) for attached microphone.

Time W: Check or select “Fast” or “Slow” Time Weighting.

3: (L) – Three.

Fr/Rdm (3 and 4): Check or select weighting network for Frontal or Random sound fields.

Frequency Weighting: Check or select “A”, “C”, “Lin.” or “All Pass” Frequency Weighting.

4: (L) – Four.

Analogue Display: Select Normal Display (Peak or RMS) or Differential Display (RMS only).

5: (L) – Five.

FSD (Ref.): Check or select one of 7 measuring ranges or internal reference signal.

6: (L) – Six.

Displayed Parameter: – Check or Select Display Function (SPL, Peak, L_{eq} etc.).

7: (L) – Seven.

Pause: Idling mode: no updating of measurement values, time or dose.

8: (L) – Eight.

Reset All (8 and 9): (R) – Idling mode: no updating of measurement values, time or dose.

9: (L) – Nine.

Reset Max./Min.: (R) – Reset only MaxP, MaxL and MinL.

Power Off/On: Switches Sound Level Meter off or on.

Front Plate

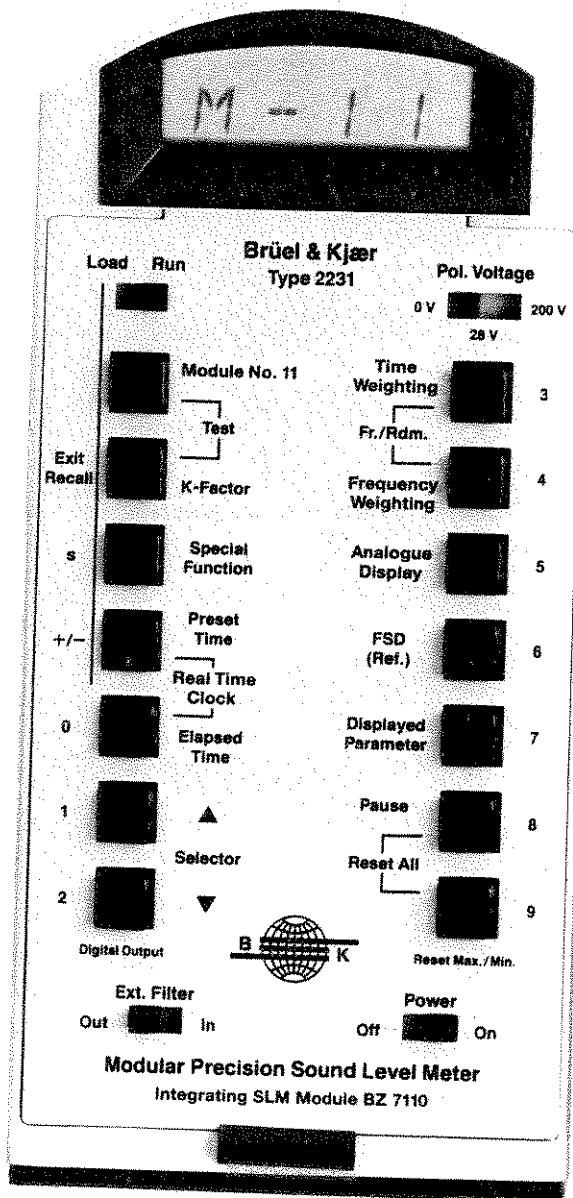

uka dk

DK BB 0753-12

